



Manual Single- and Double- Action Door Systems

Technical brochure 2021

STUDIO
OFFICE
BEYOND
TENSOR
VISUR
RP

dormakaba 

Content

Single-Action Door Systems



08 **STUDIO Rondo**



24 **STUDIO Classic**



34 **STUDIO Gala 2.0**



42 **STUDIO Arcos**

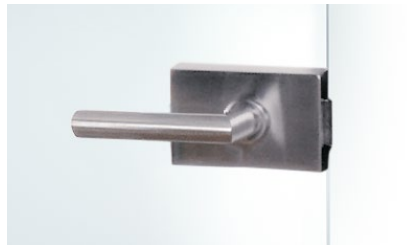

52 **STUDIO Medio**



60 **OFFICE Junior**



68 **OFFICE Classic**



76 **OFFICE Mundus**

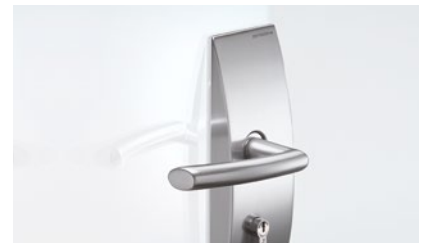

82 **OFFICE Arcos**



94 **Special Hinges**



100 **Accessories**



114 **Range of levers**

Double-Action Door Systems



122 **BEYOND**



132 **TENSOR**



142 **VISUR**



150 **RP**



156 **Accessories**



Fittings for single- and double- action doors offering unlimited possibilities for you to choose

Simple glass preparation

With its expertise in glass technology, dormakaba has designed the fittings so that the preparation of the glass is limited to the drilling of simple and quick holes in the glass. Sophisticated design features ensure optimal clamping.

Reliable operating features

High-quality materials and a robust design offer the guarantee of outstanding operating features and high reliability.

Limited suitability for use in swimming pools, saunas and brine baths

Because of the possible presence of chemicals (e.g. chlorine) in the air at swimming pools, saunas and brine baths, the fittings are not suitable for use in these areas.

OFFICE locks comply to the current DIN EN 12209

(designed for use in public buildings). Moreover these locks were tested successfully by a neutral testing institute with 500,000 latch and 100,000 locking bolt operating cycles.

STUDIO locks according to DIN 12209 tested

Type-test with 200,000 latch and 200,000 locking bolt operating cycles.

Please note that STUDIO Medio locks are not designed for use in public buildings, rather only for use in private areas.

Features	STUDIO Rondo	STUDIO Classic	STUDIO Gala 2.0	STUDIO Arcos	STUDIO Medio
max. door weight, kg (depends on hinge)	45, 50, 60	45, 50, 60	45, 50, 60	45, 50, 60	*
max. door panel width, mm	1000 ¹⁾	1000 ¹⁾	1000 ¹⁾	1000 ¹⁾	*
max. door panel height, mm	Standard frames ^{1) 3)}	Standard frames ^{1) 3)}	Standard frames ^{1) 3)}	Standard frames ^{1) 3)}	Standard frames ^{1) 3)}
Glass type	TSG/LSG	TSG/LSG	TSG/LSG	TSG/LSG	TSG/LSG
Glass thicknesses in mm	8/10	8/10	8/10	8/10	8/10
Frame depth, standard, mm	24, 40	24	24	24, 40	*
Lock types					
Low-noise "Whisper" functionality (Whisper latch = latch head partially plastic-sheated / damped latch motions)	●	●	●	●	
Adjustable lever handle follower +/- 1° for OFFICE Adjustable lever handle follower +1,5/- 1° for STUDIO to avoid "hanging follower"	●	●	●	●	
Non-locking latch	●	●	●	●	●
Non-locking latch, with levers forward	●	●	●	●	
Prepared for Europrofile cylinder	●	●	●	●	
External compliance approval to DIN EN 12209	●	●	●	●	
Prepared for round profile cylinder	●	●		●	
Warded lever lock with nightlatch function	●	●	●	●	
Warded lever lock without nightlatch function					
Bathroom lock function	●	●		●	
Strike box for double doors	●	●		●	●
Lock designs					
With follower for door levers without roses	●	●	●	●	●
For door levers with roses	●	●			
Hinge designs					
For frame pivots	●	●	●	●	
With frame pivot for aluminum frame	●				
With frame pivot for timber frame	●	●	●	●	
With frame pivot for steel frame	●	●	●	●	
For object doors					
For fixing to side panels	●				
Single-/ double-action door					
Door closer / self-closing	○	○	○	○	○
Page	8	24	34	42	52

1) For other possible glass panel widths, glass heights, glass thicknesses and rebate depths, please consult our Application Engineering department.

The glass dimensions may differ due to the following factors: type of installation, glass tolerances, general use.

2) LSG is possible in special version with MUNDUS premium fittings

3) max. 2125 mm standard dimension / max. 2108 mm frame rebate dimension

4) max. 2750 mm standard dimension (2733 mm frame rebate dimension), from 2250 mm height standard dimension (2233 mm frame rebate dimension) use third door hinge

● Standard ○ Optional

OFFICE Junior	OFFICE Classic	OFFICE Mundus	OFFICE Arcos	Special hinges	BEYOND	TENSOR	VISUR	RP Patch fittings
55, 70, 80	55, 70, 80	55, 70, 80	55, 70, 80	30, 35, 45, 55, 70, 80	80	65	85	80/110
1000, 1200 ¹⁾	1000, 1200 ¹⁾	1000, 1200 ¹⁾	1000, 1200 ¹⁾	1100 ¹⁾	1000/1200	1000 ¹⁾	1100 ¹⁾	1100, 1250 ¹⁾
Standard frames ^{1) 4)}	Standard frames ^{1) 4)}	Standard frames ^{1) 4)}	Standard frames ^{1) 4)}		2200/3000 ¹⁾	2500 ¹⁾	2500 ¹⁾	2500
TSG/LSG	TSG/LSG	TSG/LSG	TSG/LSG	TSG	TSG	TSG	TSG	TSG ²⁾
8/10	8/10	8/10	8/10	8/10	10/12	8/10/12	10/12	8/10/12/13.5
24, 40 ¹⁾	24, 40	24, 40	24, 40					
●	●	●	●					
●	●	●	●					
●	●	●	●					
●	●	●	●					
●	●	●	●					
●	●	●	●					
●	●	●	●					
●	●	●	●					
●	●	●	●					
●	●	●	●					
●	●	●	●					
●	●	●	●					
●	●	●	●					
●	●	●	●					
●	●	●	●					
●	●	●	●					
●	●	●	●	●				
●	●	●	●					
●	●	●	●					
●	●	●	●					
●	●	●	●			●	●	●
●	●	●	●			●		
SA	SA	SA	SA	SA	SA / DA	DA	DA	SA / DA
○	○	○	○		●**	●	●	●
60	68	76	82	94	122	132	142	150

* depending on the used door hinge

** As a double-action door only to use with BTS.

Content

STUDIO Rondo

10	Technical Features
12	Complete doorsets
16	Components (Locks, hinges)
58	Type illustrations
100	Accessories
114	Range of levers
169	Safety-related information



STUDIO Rondo

Technical features

- Lock insert with low-noise "whisper" functionality as standard. The whisper latch (study metal latch – partially plastics-sheathed and damped latch motions for noise minimisation) satisfy particularly high expectations. Adjustable lever handle follower $+1,5^{\circ} / -1^{\circ}$, patent pending, for avoidance of "lever handle sag" (droop). Further on a special spring supported clamp follower holds the lever handle perfectly secure.
- The fully closed lock case provides optimum protection for the internal components which themselves are of rugged unit construction.
- Locks comply to the current DIN EN 12209.
- Moreover these locks were tested successfully by a neutral testing institute with 200,000 latch and 200,000 locking bolt operating cycles.

Lock features	STUDIO Rondo	STUDIO Classic	STUDIO Gala 2.0	STUDIO Arcos
Adjustable lever handle follower from + 1.5° to - 1° for avoidance of „lever handle sag“ droop	●	●	●	●
Low-noise “whisper” functionality	●	●	●	●
Adjustable return spring	●	●	●	●
Spring-assisted clamp follower	●	●	●	●
Compliance approval to EN 12209	●	●	●	●
Lock types				
Non-locking latch	●	●	●	●
Non-locking latch, with levers forward	●	●	●	●
Prepared for Europrofile cylinder	●	●	●	●
Prepared for round profile cylinder	●	●	●	●
Warded lever lock with nightlatch function	●	●	●	●
Bathroom lock function	●	●	●	●

New standard lock functions

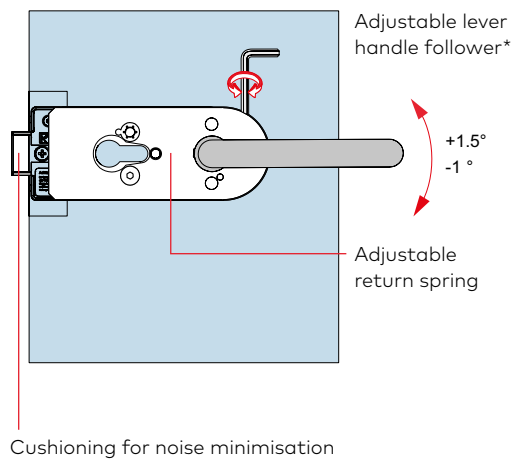

Complete doorsets for 8 and 10 mm glass thickness, locks with follower

Complying to DIN EN 12209 (see page 6).

Door weight max. 60 kg, door width max. 1,000 mm.
 Rebate depth 24 mm (for 8 mm glass thickness or 10 mm glass thickness when using an Austrian standard "Ö-Norm" latch), 26 mm (for 10 mm glass thickness).

Prepared for all levers without roses with 8 mm square spindles, spindle length for 44 mm lock thickness and 18 mm Ø follower, max. 8 mm long.

Hinges also prepared for rebate depth 28 – 40 mm available, see page 20 and following.

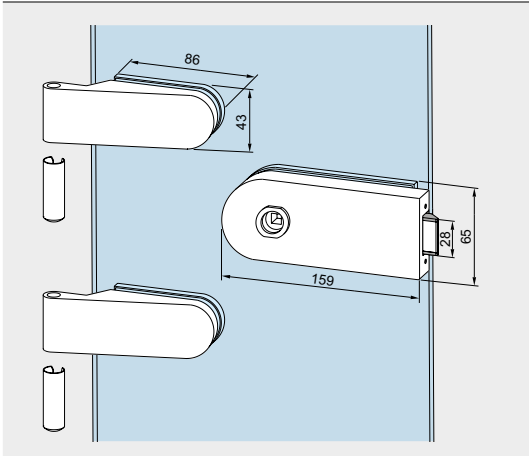
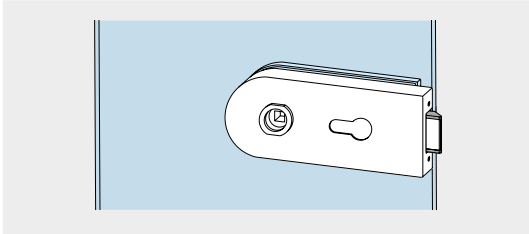
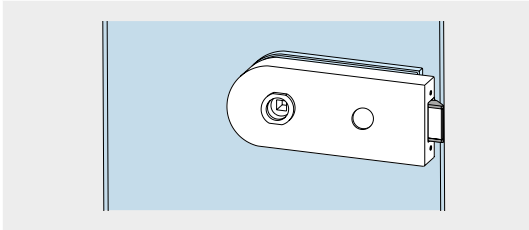
	Product description	Glass thickness	Art. No.
	Lock with 2 hinges non-locking lock, hinges with sleeves, extended colour options Weight in kg: Aluminum 1.580 Brass 2.485	8 mm 10 mm	10.100 10.130
	Lock with 2 hinges non-locking lock for lever forward, hinges with sleeves, extended colour options Weight in kg: Aluminum 1.625 Brass 2.505	8 mm 10 mm	10.101 10.131
	Lock with 2 hinges lock prepared for Europrofile cylinder, nightlatch function, hinges with sleeves, extended colour options Weight in kg: Aluminum 1.565 Brass 2.465	8 mm 10 mm	10.102 10.132
	Lock with 2 hinges lock prepared for round profile cylinder, nightlatch function, hinges with sleeves, extended colour options Weight in kg: Aluminum 1.563	8 mm 10 mm	10.108 10.129

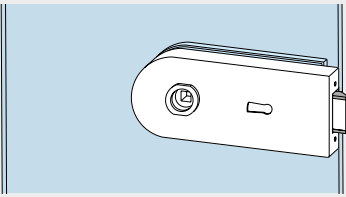
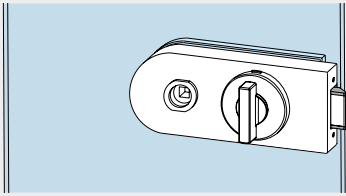
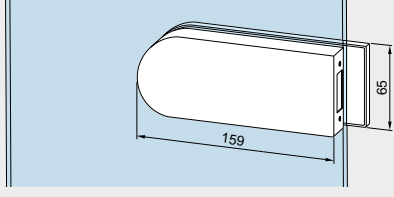
	Product description	Glass thickness	Art. No.
	<p>Lock with 2 hinges lever lock, nightlatch function, 2 keys supplied, hinges with sleeves, extended colour options</p> <p>Weight in kg: Aluminum 1.630 Brass 2.530</p>	8 mm 10 mm	10.103 10.133
	<p>Lock with 2 hinges WC-toilet door, hinges with sleeves, extended colour options</p> <p>Weight in kg: Aluminum 1.745 Brass 2.755</p>	8 mm 10 mm	10.106 10.134
	<p>Strike box with 2 hinges for pairs of doors, hinges with sleeves, extended colour options</p> <p>Weight in kg: Aluminum 1.380 Brass 2.295</p>	8 mm 10 mm	10.120 10.125

Complete doorsets for 8 mm glass thickness, locks for levers with roses

Complying to DIN EN 12209 (see page 6).

Hinges also prepared for rebate depth 28 – 40 mm available, see page 20 and following.

Door weight max. 60 kg, door width max. 1,000 mm.
 Rebate depth 24 mm (for 8 mm glass thickness or 10 mm glass thickness when using an Austrian standard "Ö-Norm" latch), 26 mm (for 10 mm glass thickness).

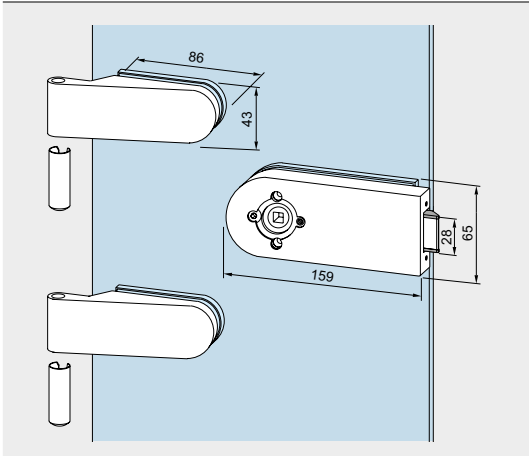
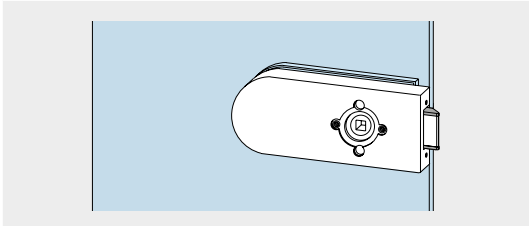
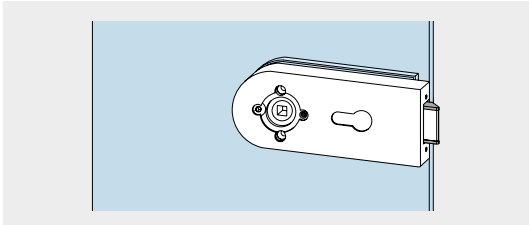
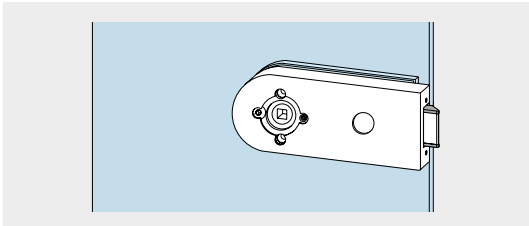
	Product description	Glass thickness	Art. No.
	<p>Lock with 2 hinges non-locking lock, hinges with sleeves</p> <p>Weight in kg: Aluminum 1.580</p>	8 mm	10.110
	<p>Lock with 2 hinges non-locking lock for lever forward, hinges with sleeves</p> <p>Weight in kg: Aluminum 1.585</p>	8 mm	10.111
	<p>Lock with 2 hinges lock prepared for Europrofile cylinder, nightlatch function, hinges with sleeves</p> <p>Weight in kg: Aluminum 1.565</p>	8 mm	10.112
	<p>Lock with 2 hinges lock prepared for round profile cylinder, nightlatch function, hinges with sleeves</p> <p>Weight in kg: Aluminum 1.563</p>	8 mm	10.118

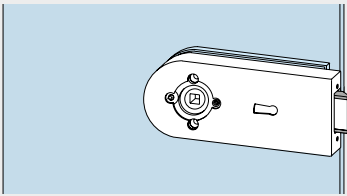
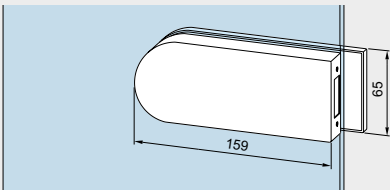
	Product description	Glass thickness	Art. No.
	<p>Lock with 2 hinges lever lock, nightlatch function, 2 keys supplied, hinges with sleeves</p> <p>Weight in kg: Aluminum 1.575</p>	8 mm	10.113
	<p>Strike box with 2 hinges for pairs of doors, hinges with sleeves</p> <p>Weight in kg: Aluminum 1.380</p>	8 mm	10.120

Locks with follower

Complying to DIN EN 12209 (see page 6).

Locks for 8 mm glass thickness (or 10 mm glass thickness when using an Austrian standard "Ö-Norm" latch), / 24 mm rebate depth, 10 mm glass thickness / 26 mm rebate depth resp.

Prepared for all levers without roses with 8 mm square spindles, spindle length for 44 mm lock thickness and 18 mm Ø follower, max. 8 mm long.

Hinges also prepared for rebate depth 28 – 40 mm available, see page 20 and following.

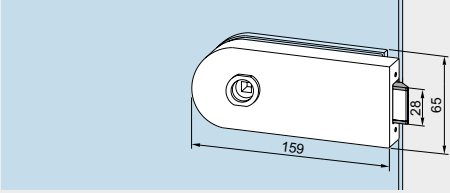
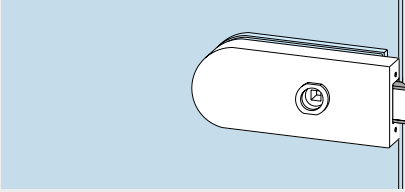
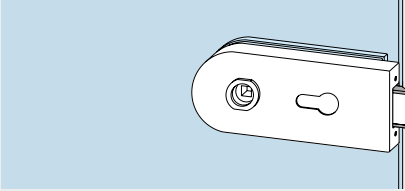
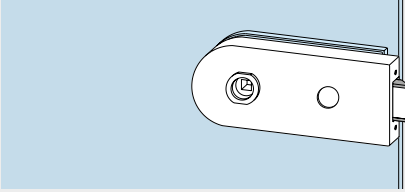
	Product description	Art. No.
	<p>Lock non-locking, extended colour options</p> <p>Weight in kg: Aluminum 0.840 Brass 1.055</p>	10.200
	<p>Lock non-locking, with follower forward, extended colour options</p> <p>Weight in kg: Aluminum 0.845 Brass 1.055</p>	10.201
	<p>Lock prepared for Europrofile cylinder, nightlatch function, extended colour options</p> <p>Weight in kg: Aluminum 0.815 Brass 1.030</p>	10.202
	<p>Lock prepared for round profile cylinder , nightlatch function, extended colour options</p> <p>Weight in kg: Aluminum 0.813</p>	10.207

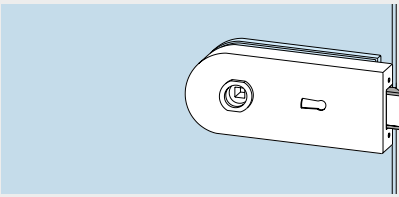
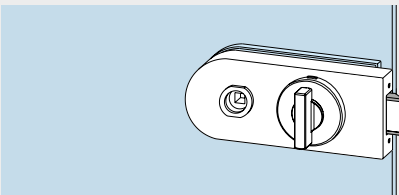
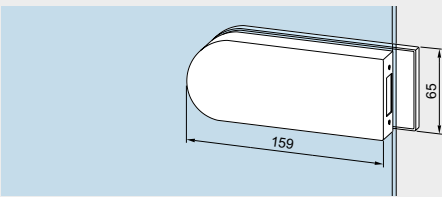
	Product description	Art. No.
	<p>Lock lever lock, nightlatch function, 2 keys supplied, extended colour options</p> <p>Weight in kg: Aluminum 0.850 Brass 1.090</p>	<p>10.203</p>
	<p>Lock WC-toilet door, extended colour options</p> <p>Weight in kg: Aluminum 1.106 Brass 1.398</p>	<p>10.206</p>
	<p>Strike box for pairs of doors, extended colour options</p> <p>Weight in kg: Aluminum 0.610 Brass 0.903</p>	<p>10.220</p>

Locks for levers with roses

Complying to DIN EN 12209 (see page 6).

Hinges also prepared for rebate depth 28 – 40 mm available, see page 20 and following.

Locks for 8 mm glass thickness (or 10 mm glass thickness when using an Austrian standard "Ö-Norm" latch), / 24 mm rebate depth, 10 mm glass thickness / 26 mm rebate depth resp.

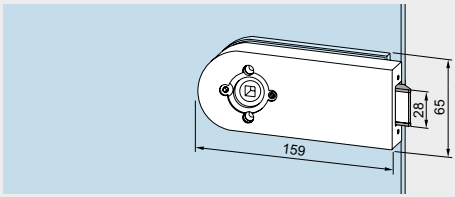
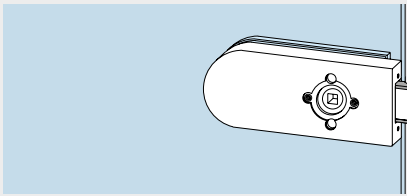
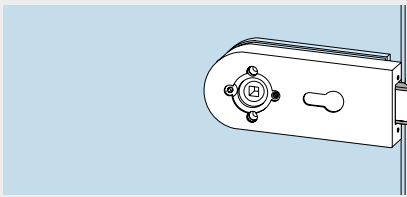
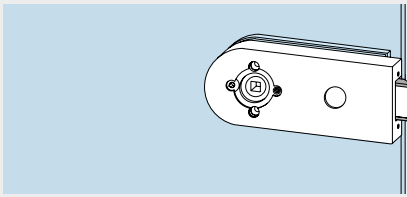
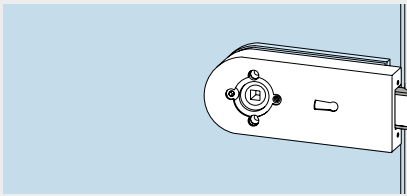
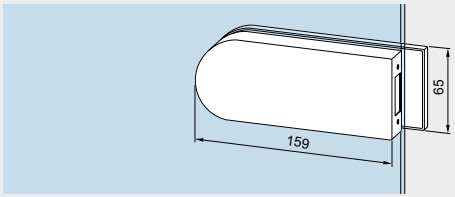
	Product description	Art. No.
	<p>Lock non-locking, extended colour options</p> <p>Weight in kg: Aluminum 1.580 Brass 2.485</p>	10.210
	<p>Lock non-locking, with follower forward, extended colour options</p> <p>Weight in kg: Aluminum 1.625 Brass 2.505</p>	10.211
	<p>Lock prepared for Europrofile cylinder, nightlatch function, extended colour options</p> <p>Weight in kg: Aluminum 1.565 Brass 2.465</p>	10.212
	<p>Lock prepared for round profile cylinder, nightlatch function, extended colour options</p> <p>Weight in kg: Aluminum 0.810</p>	10.217
	<p>Lock lever lock, nightlatch function, 2 keys supplied, extended colour options</p> <p>Weight in kg: Aluminum 1.630 Brass 2.530</p>	10.213
	<p>Strike box for pairs of doors, extended colour options</p> <p>Weight in kg: Aluminum 0.610 Brass 0.903</p>	10.220

Space for your notes

Hinges for 8 mm glass thickness

Door width max. 1,000 mm

	Product description	Art. No.
	<p>Hinge with frame pivot complete with sleeve, to suit rebate depth 24 mm, extended colour options door weight max. 60 kg</p> <p>Weight in kg: Aluminum 0.319 Brass 0.688</p>	<p>10.230</p>
	<p>Hinge with frame pivot complete with sleeve, to suit rebate depth 28 – 30 mm, door weight max. 50 kg</p> <p>Weight in kg: Aluminum 0.336 Brass 0.806</p>	<p>10.233 (not illustr.)</p>
	<p>Filler piece with screws for rebate depth 31 – 39 mm, (please indicate), door weight max. 50 kg, used in combination with hinge 10.230</p> <p>Weight in kg: Aluminum 0.144</p>	<p>10.420 (not illustr.)</p>
	<p>Hinge with frame pivot complete with sleeve and filler piece to suit 40 mm rebate depth, door weight max. 50 kg</p> <p>Weight in kg: Aluminum 0.486</p>	<p>10.234 (not illustr.)</p>

Hinges for 8 mm glass thickness

Door width max. 1,000 mm

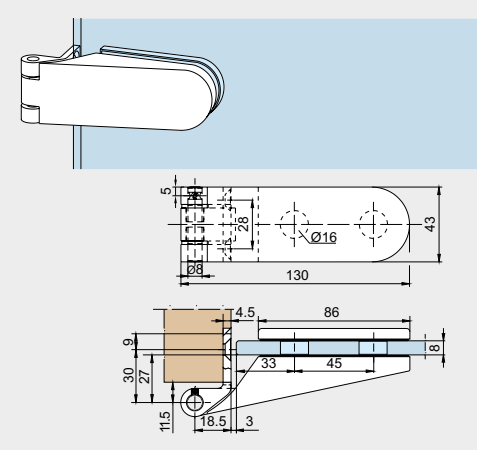
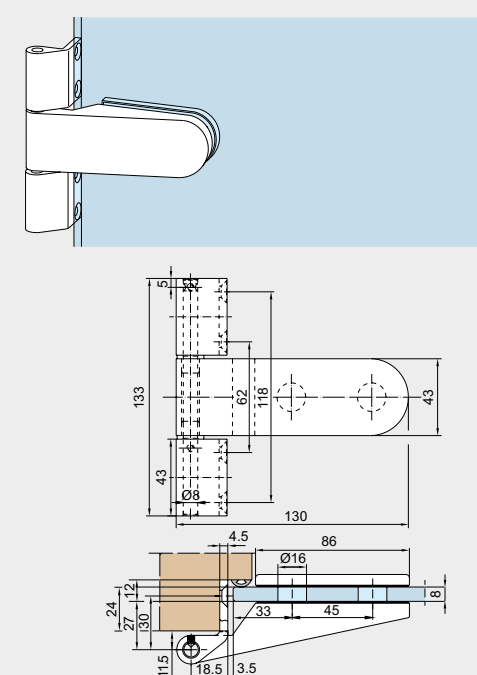
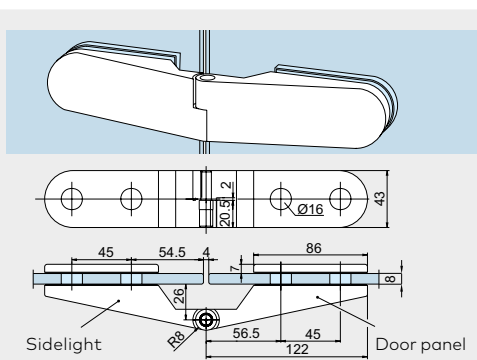
	Product description	Art. No.
	<p>Hinge with frame pivot for wooden frames, hinge flap for mortising into frame, stainless steel pin, door weight max. 45 kg</p> <p>Weight in kg: Aluminum 0.321</p>	<p>10.232</p>
	<p>Strengthened hinge with frame pivot for wooden frames, hinge flap for mortising into frame, stainless steel pin, door weight max. 60 kg</p> <p>Weight in kg: Aluminum 0.433</p>	<p>10.235</p>
	<p>Hinge for mounting onto sidelights, stainless steel pin, door weight max. 45 kg</p> <p>Weight in kg: Aluminum 0.557</p> <p>Note: Opening angle max. 100°. You will find more information on special solutions for opening angles >100° in our DETAIL 10-255. Please also feel free to consult our Application Engineering department.</p>	<p>10.244 L 10.246 R (not illustr.)</p>

Hinges for 10 mm glass thickness

Door width max. 1,000 mm

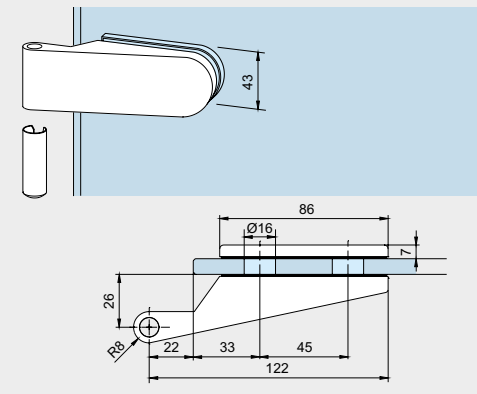
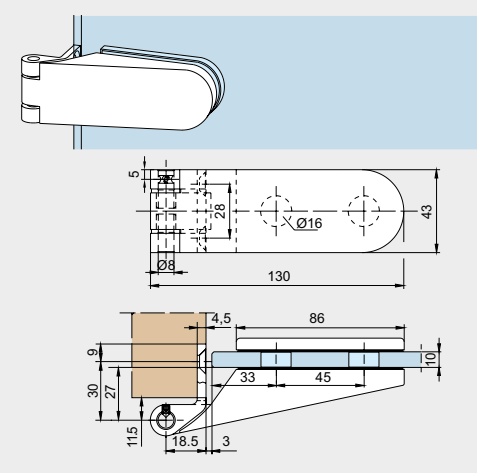
	Product description	Art. No.
	<p>Hinge with frame pivot complete with sleeve, rebate depth 26 mm, extended colour options, door weight max. 60 kg</p> <p>Weight in kg: Aluminum 0.319 Brass 0.688</p>	<p>10.236</p>
	<p>Hinge with frame pivot for wooden frames, hinge flap for mortising into frame, stainless steel pin, Panel weight max. 45 kg</p> <p>Weight in kg: Aluminum 0.321</p>	<p>10.238</p>

Hinges for 10 mm glass thickness

Door width max. 1,000 mm

Product description

Art. No.

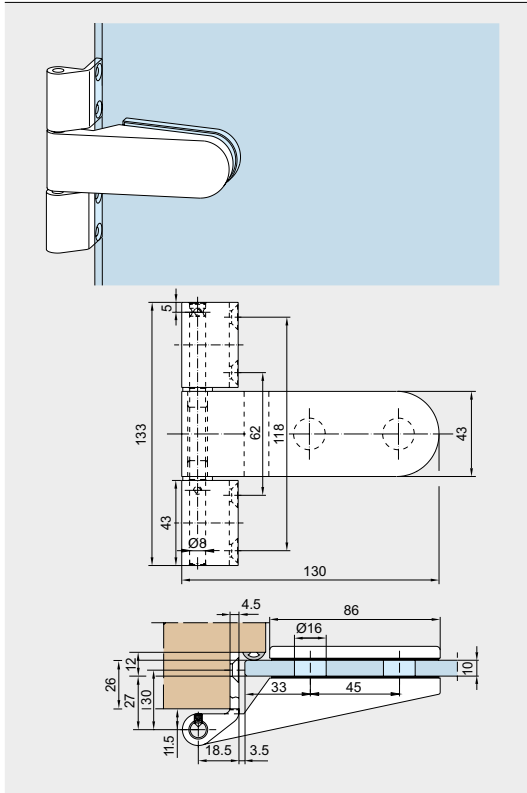

Strengthened hinge with frame pivot for wooden frames,

10.239

hinge flap for mortising into frame, stainless steel pin, door weight max. 60 kg

Weight in kg:
Aluminum 0.433

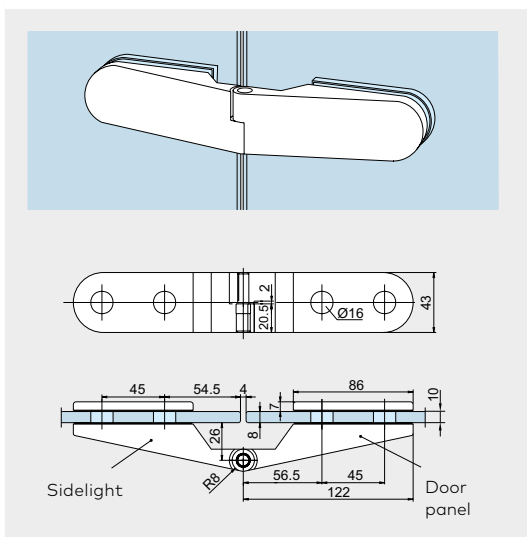

Hinge for mounting onto sidelight

10.245 L
10.247 R
(not illustr.)

stainless steel pin,
door weight max. 45 kg

Weight in kg:
Aluminum 0.557

Note: Opening angle max. 100°. You will find more information on special solutions for opening angles >100° in our DETAIL 10-255. Please also feel free to consult our Application Engineering department.

Content

STUDIO Classic

26	Technical Features
28	Complete doorsets
30	Components (Locks, hinges)
58	Type illustrations
100	Accessories
114	Range of levers
169	Safety-related information



STUDIO Classic

Technical features

- Lock insert with low-noise "whisper" functionality as standard. The whisper latch (study metal latch – partially plastics-sheathed and damped latch motions for noise minimisation) satisfy particularly high expectations. Adjustable lever handle follower $+1,5^\circ / -1^\circ$, patent pending, for avoidance of "lever handle sag" (droop). Further on a special spring supported clamp follower holds the lever handle perfectly secure.
- The fully closed lock case provides optimum protection for the internal components which themselves are of rugged unit construction.
- Locks comply to the current DIN EN 12209.
- Moreover these locks were tested successfully by a neutral testing institute with 200,000 latch and 200,000 locking bolt operating cycles.

Lock features	STUDIO Rondo	STUDIO Classic	STUDIO Gala 2.0	STUDIO Arcos
Adjustable lever handle follower from + 1.5° to - 1° for avoidance of „lever handle sag“ droop	●	●	●	●
Low-noise “whisper” functionality	●	●	●	●
Adjustable return spring	●	●	●	●
Spring-assisted clamp follower	●	●	●	●
Compliance approval to EN 12209	●	●	●	●
Lock types				
Non-locking latch	●	●	●	●
Non-locking latch, with levers forward	●	●	●	●
Prepared for Europrofile cylinder	●	●	●	●
Prepared for round profile cylinder	●	●	●	●
Warded lever lock with nightlatch function	●	●	●	●
Bathroom lock function	●	●	●	●

New standard lock functions

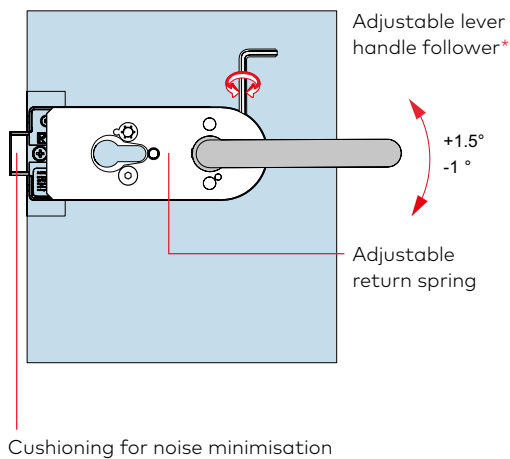

Complete doorsets for 8 and 10 mm glass thickness, locks with follower

Complying to DIN EN 12209, with regard to type test (see page 6).

Prepared for all levers without roses with 8 mm square spindles, spindle length for 44 mm lock thickness and 18 mm Ø follower, max. 8 mm long.

Door weight max. 60 kg, door width max. 1,000 mm.
 Rebate depth 24 mm (for 8 mm glass thickness or 10 mm glass thickness when using an Austrian standard "Ö-Norm" latch), 26 mm (for 10 mm glass thickness)

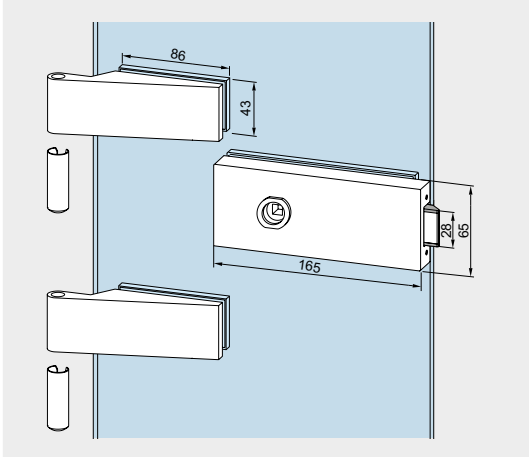
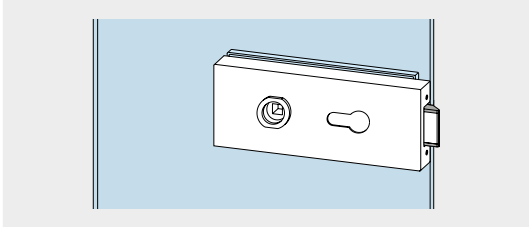
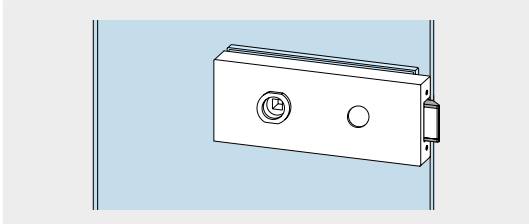
	Product description	Glass thickness	Art. No.
	Lock with 2 hinges non-locking lock, hinges with sleeves Weight in kg: Aluminum 1.580	8 mm 10 mm	10.050 10.055
	Lock with 2 hinges non-locking lock with follower forward, hinges with sleeves Weight in kg: Aluminum 1.625	8 mm 10 mm	10.051 10.056
	Lock with 2 hinges lock prepared for Europrofile cylinder, nightlatch function, hinges with sleeves Weight in kg: Aluminum 1.565	8 mm 10 mm	10.052 10.057
	Lock with 2 hinges lock prepared for round profile cylinder, nightlatch function, hinges with sleeves Weight in kg: Aluminum 1.563	8 mm 10 mm	10.049 10.060

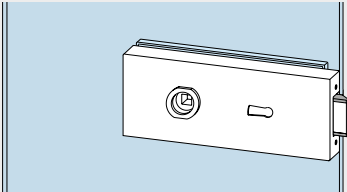
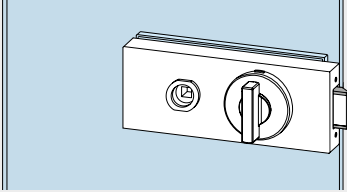
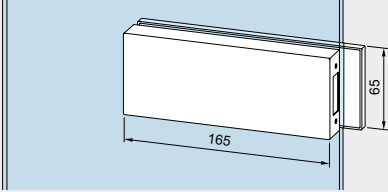
	Product description	Glass thickness	Art. No.
	<p>Lock with 2 hinges lever lock, nightlatch function, 2 keys supplied, hinges with sleeves</p> <p>Weight in kg: Aluminum 1.630</p>	8 mm 10 mm	10.053 10.058
	<p>Lock with 2 hinges WC-toilet door, hinges with sleeves</p> <p>Weight in kg: Aluminum 1.721</p>	8 mm 10 mm	10.054 10.059
	<p>Strike box with 2 hinges for pairs of doors, hinges with sleeves</p> <p>Weight in kg: Aluminum 1.380</p>	8 mm 10 mm	10.034 10.039

Locks with follower

Complying to DIN EN 12209, with regard to type test (see page 6),

Locks for 8 mm glass thickness (or 10 mm glass thickness when using an Austrian standard "Ö-Norm" latch), / 24 mm rebate depth, 10 mm glass thickness / 26 mm rebate depth resp.

Prepared for all levers without roses with 8 mm square spindles, spindle length for 44 mm lock thickness and 18 mm Ø follower, max. 8 mm long.

Hinges see page 33.

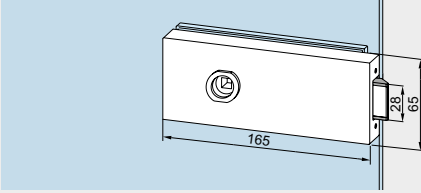
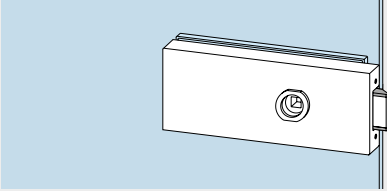
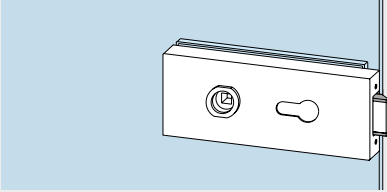
	Product description	Art. No.
	<p>Lock non-locking</p> <p>Weight in kg: Aluminum 0.840</p>	10.001
	<p>Lock non-locking, with follower forward</p> <p>Weight in kg: Aluminum 0.845</p>	10.002
	<p>Lock prepared for Europrofile cylinder, nightlatch function</p> <p>Weight in kg: Aluminum 0.815</p>	10.003

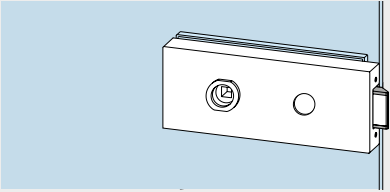
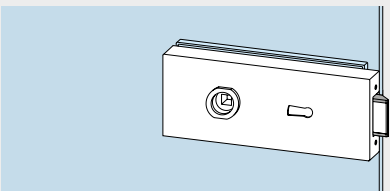
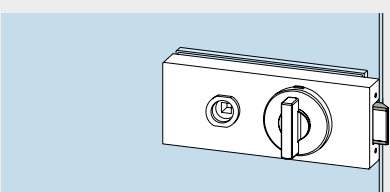
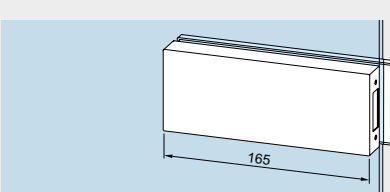
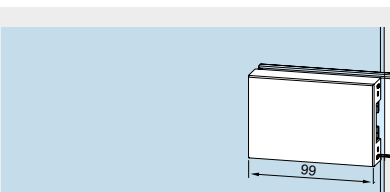
	Product description	Art. No.
	<p>Lock prepared for round profile cylinder, nightlatch function</p> <p>Weight in kg: Aluminum 0.813</p>	<p>10.007</p>
	<p>Lock lever lock, nightlatch function, 2 keys supplied</p> <p>Weight in kg: Aluminum 0.850</p>	<p>10.004</p>
	<p>Lock WC-toilet door</p> <p>Weight in kg: Aluminum 1.111</p>	<p>10.006</p>
	<p>Strike box for pairs of doors</p> <p>Weight in kg: Aluminum 0.610</p>	<p>10.005</p>
	<p>Strike box short for pairs of doors</p> <p>Weight in kg: Aluminum 0.610</p>	<p>10.512</p>

Locks for levers with roses

Complying to DIN EN 12209, with regard to type test (see page 6).

Hinges see page 33.

Locks for 8 mm glass thickness (or 10 mm glass thickness when using an Austrian standard "Ö-Norm" latch), / 24 mm rebate depth, 10 mm glass thickness / 26 mm rebate depth resp.

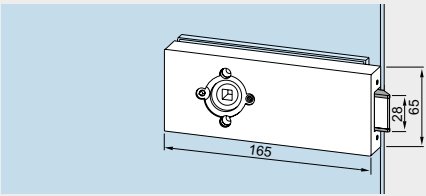
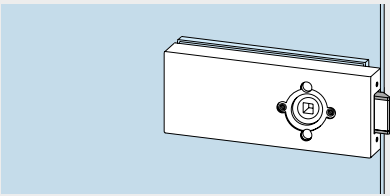
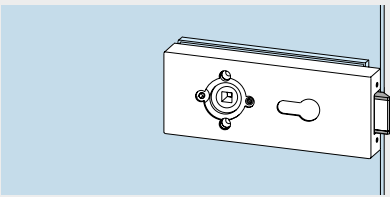
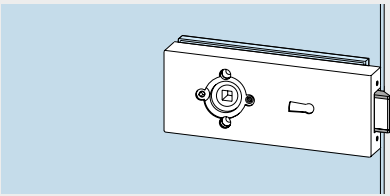
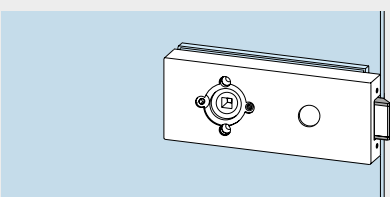
	Product description	Art. No.
	<p>Lock non-locking,</p> <p>Weight in kg: Aluminum 1.580</p>	10.040
	<p>Lock non-locking, with follower forward</p> <p>Weight in kg: Aluminum 0.845</p>	10.041
	<p>Lock prepared for Europrofile cylinder, nightlatch function</p> <p>Weight in kg: Aluminum 0.815</p>	10.042
	<p>Lock lever lock, nightlatch function, 2 keys supplied</p> <p>Weight in kg: Aluminum 0.850</p>	10.043
	<p>Lock prepared for round profile cylinder, nightlatch function</p> <p>Weight in kg: Aluminum 0.813</p>	10.044

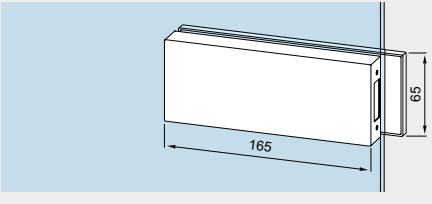
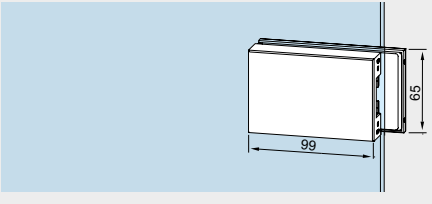
	Product description	Art. No.
	Strike box for pairs of doors Weight in kg: Aluminum 0.610	10.005
	Strike box short for pairs of doors Weight in kg: Aluminum 0.610	10.512

Door hinges for 8 mm and 10 mm glass thickness

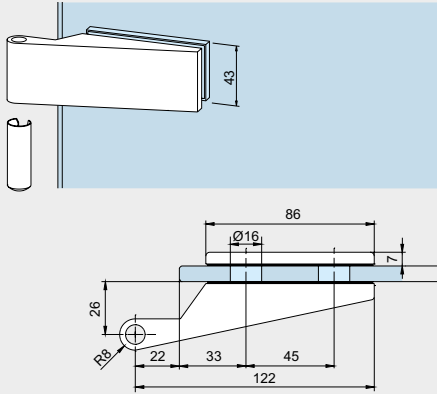
	Product description	Glass thickness	Art. No.
	Hinge with frame pivot complete with sleeve 24 mm rebate depth	8 mm	10.021
	26 mm rebate depth	10 mm	10.020
	Weight in kg: Aluminum 0.319		

Content

STUDIO Gala 2.0

36	Technical Features
38	Complete doorsets
39	Components (Locks, hinges)
58	Type illustrations
100	Accessories
114	Range of levers
169	Safety-related information



STUDIO Gala 2.0

Technical features

- Lock insert with low-noise “whisper” functionality as standard. The whisper latch (study metal latch – partially plastics-sheathed and damped latch motions for noise minimisation) satisfy particularly high expectations. Adjustable lever handle follower $+1,5^\circ / -1^\circ$, patent pending, for avoidance of “lever handle sag” (droop). Further on a special spring supported clamp follower holds the lever handle perfectly secure.
- The fully closed lock case provides optimum protection for the internal components which themselves are of rugged unit construction.
- Locks comply to the current DIN EN 12209.
- Moreover these locks were tested successfully by a neutral testing institute with 200,000 latch and 200,000 locking bolt operating cycles.

Lock features	STUDIO Rondo	STUDIO Classic	STUDIO Gala 2.0	STUDIO Arcos
Adjustable lever handle follower from + 1.5° to - 1° for avoidance of „lever handle sag“ droop	●	●	●	●
Low-noise “whisper” functionality	●	●	●	●
Adjustable return spring	●	●	●	●
Spring-assisted clamp follower	●	●	●	●
Compliance approval to EN 12209	●	●	●	●
Lock types				
Non-locking latch	●	●	●	●
Non-locking latch, with levers forward	●	●	●	●
Prepared for Europrofile cylinder	●	●	●	●
Prepared for round profile cylinder	●	●	●	●
Warded lever lock with nightlatch function	●	●	●	●
Bathroom lock function	●	●	●	●

New standard lock functions

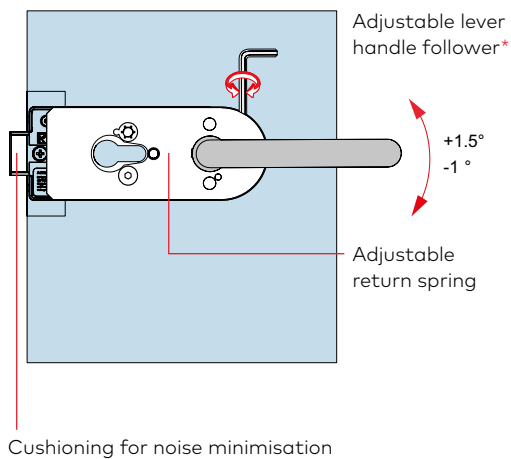

Complete doorsets for 8 mm glass thickness, locks with follower

Complying to DIN EN 12209, with regard to type test (see page 6).

Prepared for all levers without roses with 8 mm square spindles, spindle length for 44 mm lock thickness and 18 mm Ø follower, max. 8 mm long.

Door weight max. 60 kg, door width max. 1,000 mm rebate depth 24 mm (for 8 mm glass thickness).

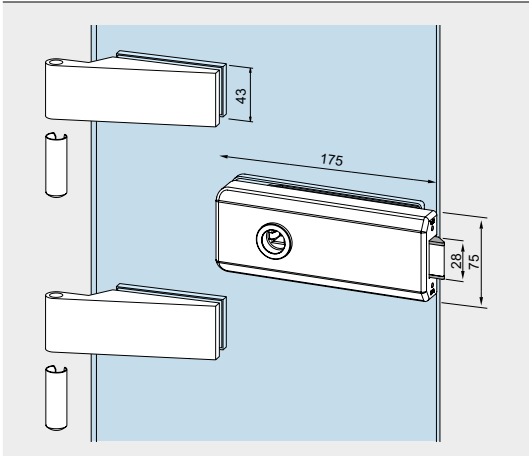
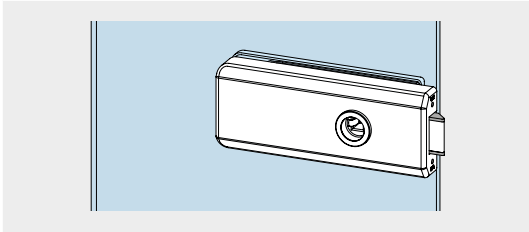
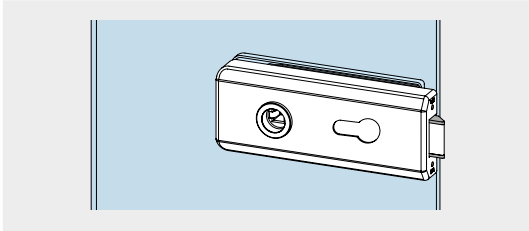
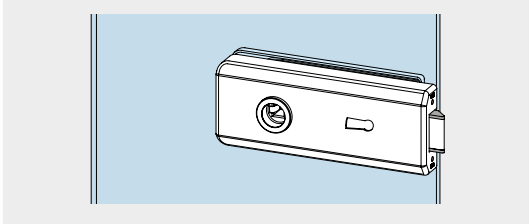
	Product description	Art. No.
	<p>Lock with 2 hinges non-locking lock, hinges with sleeves</p> <p>Weight in kg: Aluminum 1.920</p>	19.620
	<p>Lock with 2 hinges non-locking lock with follower forward, hinges with sleeves</p> <p>Weight in kg: Aluminum 1.880</p>	19.621
	<p>Lock with 2 hinges lock prepared for Europrofile cylinder, nightlatch function, hinges with sleeves</p> <p>Weight in kg: Aluminum 1.915</p>	19.622
	<p>Lock with 2 hinges lever lock, nightlatch function, 2 keys supplied, hinges with sleeves</p> <p>Weight in kg: Aluminum 1.965</p>	19.623

Locks with follower

Complying to DIN EN 12209, with regard to type test (see page 6).

Locks for 8 mm glass thickness / 24 mm rebate depth.

Prepared for all levers without roses with 8 mm square spindles, spindle length for 44 mm lock thickness and 18 mm Ø follower, max. 8 mm long.

Hinges see page 40.

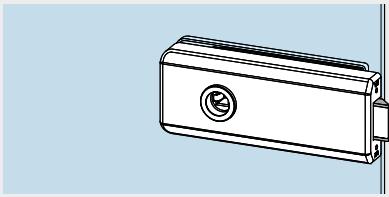
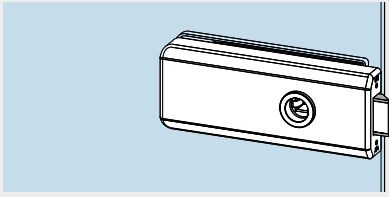
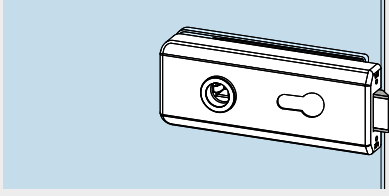
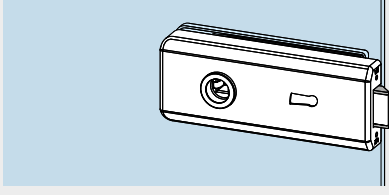
	Product description	Art. No.
	<p>Lock non-locking</p> <p>Weight in kg: Aluminum 0.690</p>	19.610
	<p>Lock non-locking, with follower forward</p> <p>Weight in kg: Aluminum 0.679</p>	19.611
	<p>Lock prepared for Europrofile cylinder, nightlatch function</p> <p>Weight in kg: Aluminum 0.690</p>	19.612
	<p>Lock lever lock, nightlatch function, 2 keys supplied</p> <p>Weight in kg: Aluminum 0.718</p>	19.613

Door hinges

	Product description	Glass thickness	Art. No.
	Hinge with frame pivot complete with sleeve 24 mm rebate depth	8 mm	10.021
	26 mm rebate depth Weight in kg: Aluminum 0.319	10 mm	10.020
	Hinge for frame pivots with sleeve bolt steel zinc-plated panel weight max. 80 kg Weight in kg: Aluminum 0.358		11.288*
	* Finish satin stainless steel (700) not usable with 11.405 (page 103).		

Space for your notes

Content

STUDIO Arcos

44	Technical Features
46	Complete doorsets
48	Components (Locks, hinges)
58	Type illustrations
100	Accessories
114	Range of levers
169	Safety-related information



STUDIO Arcos

Technical features

- Lock insert with low-noise "whisper" functionality as standard. The whisper latch (study metal latch – partially plastics-sheathed and damped latch motions for noise minimisation) satisfy particularly high expectations. Adjustable lever handle follower $+1,5^\circ / -1^\circ$, patent pending, for avoidance of "lever handle sag" (droop). Further on a special spring supported clamp follower holds the lever handle perfectly secure.
- The fully closed lock case provides optimum protection for the internal components which themselves are of rugged unit construction.
- Locks comply to the current DIN EN 12209.
- Moreover these locks were tested successfully by a neutral testing institute with 200,000 latch and 200,000 locking bolt operating cycles.

Lock features	STUDIO Rondo	STUDIO Classic	STUDIO Gala 2.0	STUDIO Arcos
Adjustable lever handle follower from + 1.5° to - 1° for avoidance of „lever handle sag“ droop	●	●	●	●
Low-noise “whisper” functionality	●	●	●	●
Adjustable return spring	●	●	●	●
Spring-assisted clamp follower	●	●	●	●
Compliance approval to EN 12209	●	●	●	●
Lock types				
Non-locking latch	●	●	●	●
Non-locking latch, with levers forward	●	●	●	●
Prepared for Europrofile cylinder	●	●	●	●
Prepared for round profile cylinder	●	●	●	●
Warded lever lock with nightlatch function	●	●	●	●
Bathroom lock function	●	●	●	●

New standard lock functions

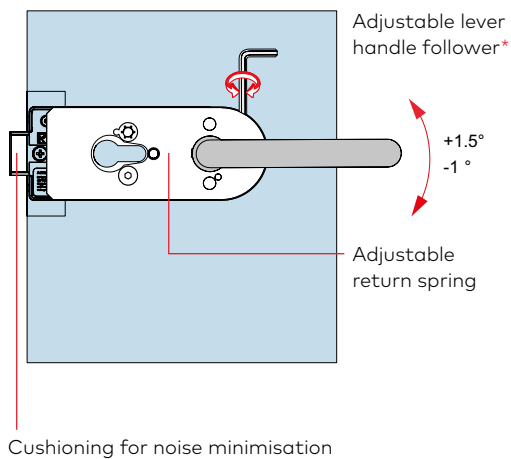

Complete doorsets for 8 mm glass thickness, locks with follower

Locks acc. to DIN 12209, according to type testing (see page 6).

Door weight max. 60 kg, door width max. 1,000 mm rebate depth 24 mm (for 8 mm glass thickness).

Prepared for all levers without roses with 8 mm square spindles, spindle length for 44 mm lock thickness and 18 mm Ø follower, max. 8 mm long.

Hinges to suit rebate depth 28–40 mm see page 50.

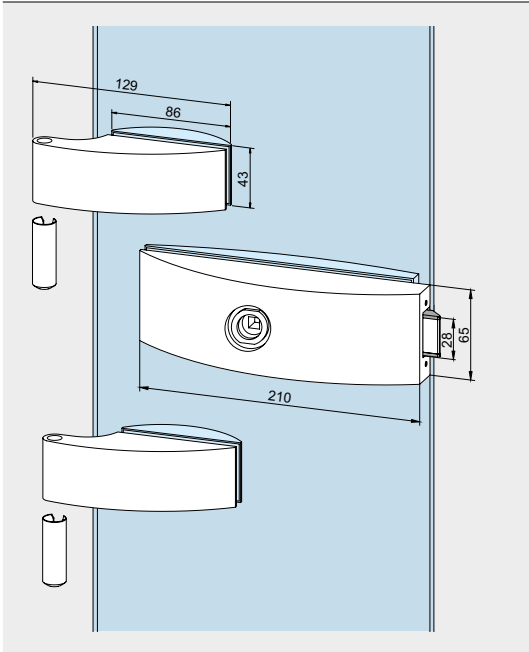
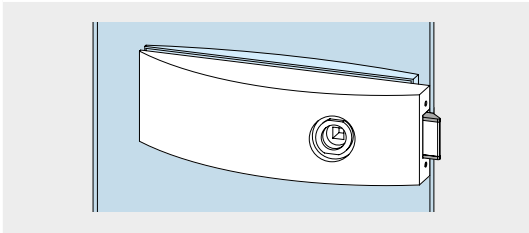
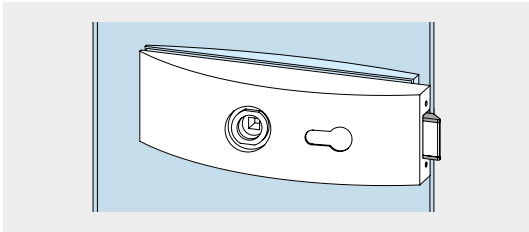
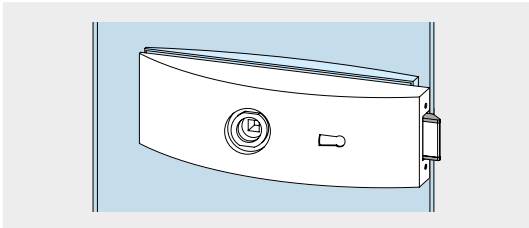
	Product description	Glass thickness	Art. No.
	<p>Lock with 2 hinges non-locking lock, hinges with sleeves</p> <p>Weight in kg: Aluminum 1.580</p>	8 mm	24.100
	<p>Lock with 2 hinges non-locking lock with follower forward, hinges with sleeves</p> <p>Weight in kg: Aluminum 1.625</p>	8 mm	24.101
	<p>Lock with 2 hinges lock prepared for Europrofile cylinder, nightlatch function, hinges with sleeves</p> <p>Weight in kg: Aluminum 1.565</p>	8 mm	24.102
	<p>Lock with 2 hinges lever lock, nightlatch function, 2 keys supplied, hinges with sleeves</p> <p>Weight in kg: Aluminum 1.630</p>	8 mm	24.103

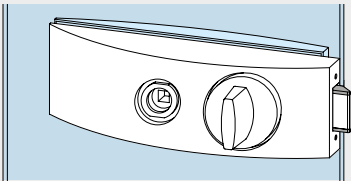
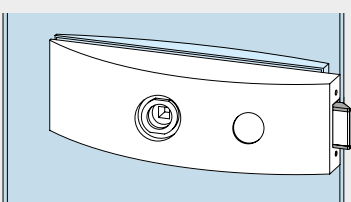
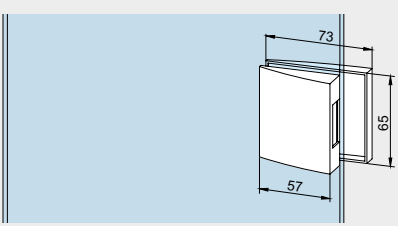
	Product description	Glass thickness	Art. No.
	<p>Lock with 2 hinges WC-toilet door, hinges with sleeves</p> <p>Weight in kg: Aluminum 1.716</p>	8 mm	24.106
	<p>Lock with 2 hinges prepared for round profile cylinder, hinges with sleeves</p> <p>Weight in kg: Aluminum 1.630</p>	8 mm	24.108
	<p>Strike box with 2 hinges for pairs of doors, hinges with sleeves</p> <p>Weight in kg: Aluminum 1.380</p>	8 mm	24.120

Locks with follower

Locks acc. to DIN 12209, according to type testing (see page 6).

Locks for 8 mm glass thickness (or 10 mm glass thickness when using an Austrian standard "Ö-Norm" latch) / 24 mm rebate depth, 10 mm glass thickness / 26 mm rebate depth resp.

Prepared for all levers without roses with 8 mm square spindles, spindle length for 44 mm lock thickness and 18 mm Ø follower, max. 8 mm long. Hinges to suit rebate depth 28–40 mm see page 50.

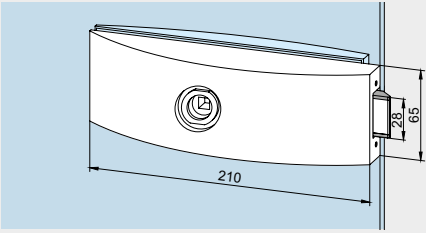
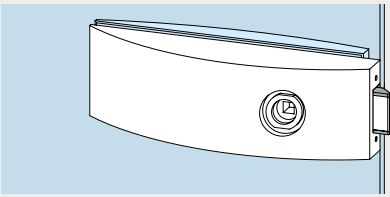
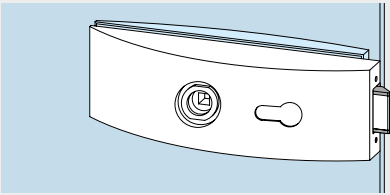
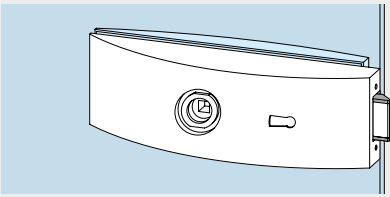
	Product description	Art. No.
	<p>Lock non-locking</p> <p>Weight in kg: Aluminum 0.840</p>	24.200
	<p>Lock non-locking, with follower forward</p> <p>Weight in kg: Aluminum 0.845</p>	24.201
	<p>Lock prepared for Europrofile cylinder, nightlatch function</p> <p>Weight in kg: Aluminum 0.815</p>	24.202
	<p>Lock lever lock, nightlatch function, 2 keys supplied</p> <p>Weight in kg: Aluminum 0.850</p>	24.203

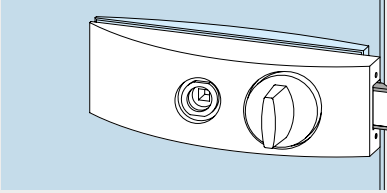
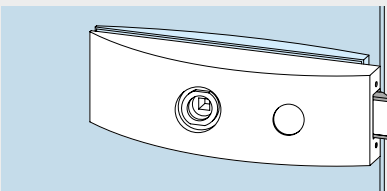
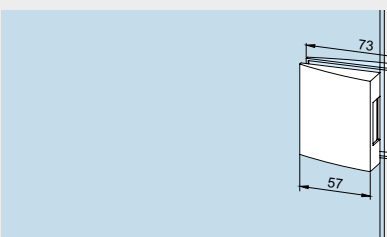
	Product description	Art. No.
	<p>Lock WC – toilet door</p> <p>Weight in kg: Aluminum 1.111</p>	<p>24.206</p>
	<p>Lock prepared for round profile cylinder</p> <p>Weight in kg: Aluminum 0.850</p>	<p>24.207</p>
	<p>Strike box for pairs of doors</p> <p>Weight in kg: Aluminum 0.610</p>	<p>24.220</p>

Hinges

for 8 mm glass thickness, for rebate depth 24 mm. Door width max. 1,000 mm.

	Product description	Art. No.
	<p>Hinge for frame pivot complete with sleeve, to suit rebate depth 24 mm door weight max. 60 kg</p> <p>Weight in kg: Aluminum 0.319</p>	<p>24.230</p>
	<p>Filler piece with screws for rebate depth 28–40 mm, (please indicate), door weight max. 50 kg, used in combination with hinge 24.230 or 10.021</p> <p>Weight in kg: Aluminum 0.144</p>	<p>24.420 (not illustr.)</p>

for 10 mm glass thickness, for rebate depth 26 mm. Door width max. 1,000 mm.

	Product description	Art. No.
	<p>Hinge for frame pivot complete with sleeve, door weight max. 60 kg</p> <p>Weight in kg: Aluminum 0.319</p>	<p>24.236</p>

Special hinges

	Product description	Glass thickness	Art. No.
	<p>Arcos hinge with frame pivot for non-rebated frames</p> <p>hinge flap for screwing onto frame, stainless steel pin, plastic bushing, door weight max. 55 kg, door width max. 1,000 mm</p> <p>Weight in kg: Aluminum 0.205</p>	<p>8 mm 10 mm</p>	<p>25.451</p>

Content

STUDIO Medio

54	Components
58	Type illustrations
100	Accessories
114	Range of levers
169	Safety-related information



STUDIO Medio

Locks with follower

Locks for 8 + 10 mm glass thickness / 24 mm rebate depth

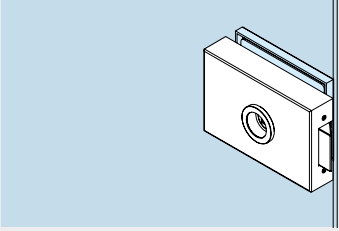
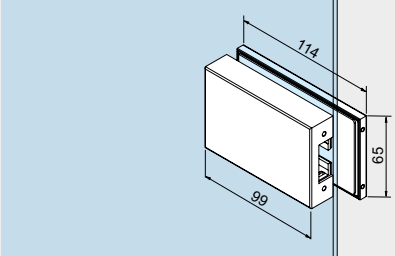
	Product description	Glass thickness	Art. No.
	<p>STUDIO Medio lock</p> <p>Weight in kg: Aluminum 0.840</p>	<p>8 mm 10 mm</p>	<p>10.510 10.509</p>
	<p>STUDIO Medio strike box, short</p> <p>Weight in kg: Aluminum 0.610</p>	<p>8 mm and 10 mm</p>	<p>10.512</p>

For 8 mm glass thickness in 24 mm rebate depth

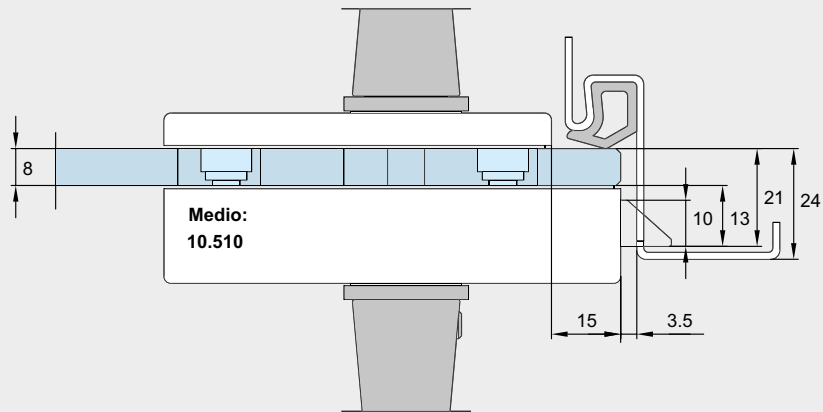

For 10 mm glass thickness in 24 mm rebate depth

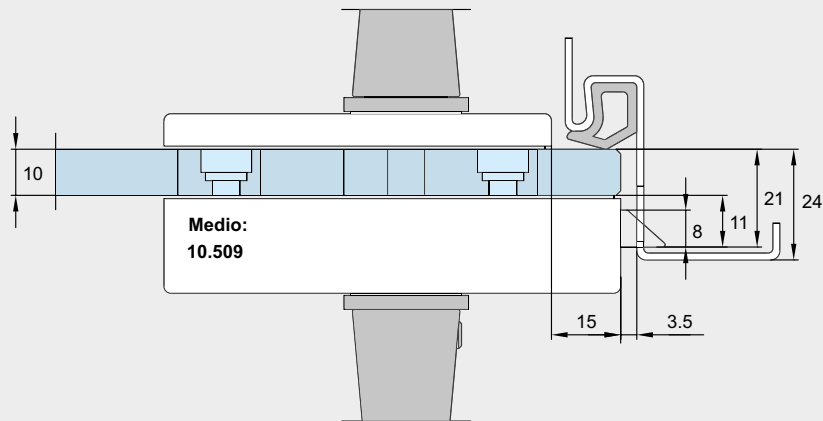

Applications with an occasional door/sidelight:

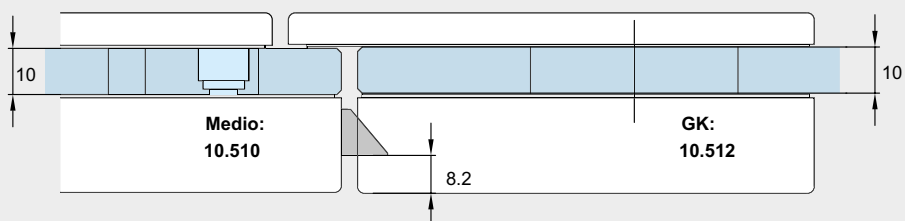
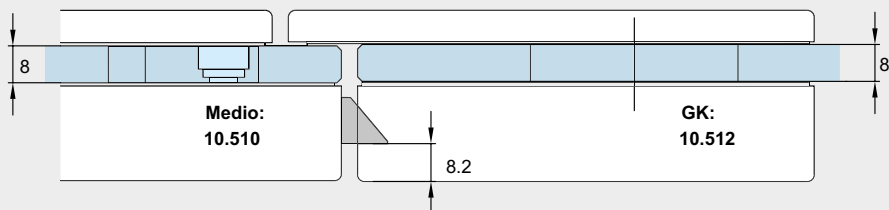

Applications with an occasional door / sidelight are always designed with lock type 10.510 for 8 mm glass, irrespective of whether the glass thickness is 8 mm or 10 mm.

Installation details and sections for frame pivots

STUDIO Medio

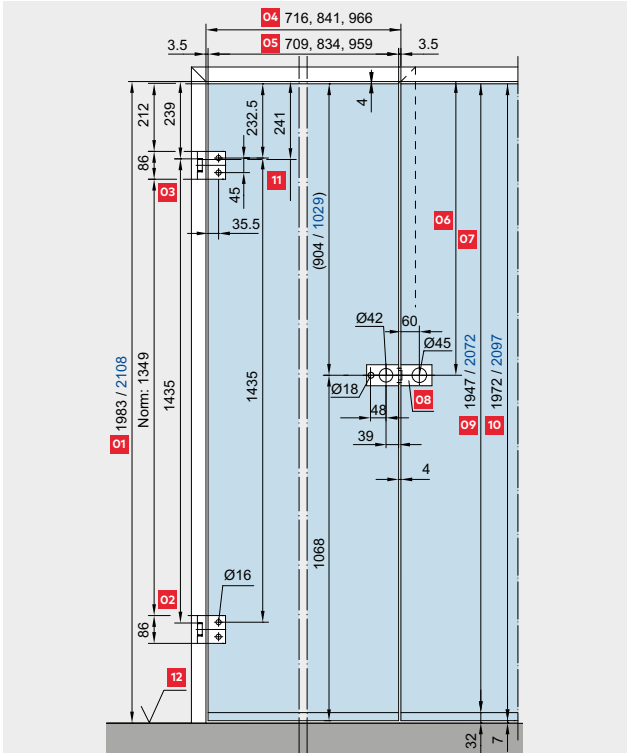

O1 Frame rebate height O2 Standard hinge support to DIN 18 111 O3 Standard hinge support O4 Frame rebate width
 O5 Glass width O6 Centre lock bolt O7 Usually 908 / 1033 mm for doors 1972 / 2108 mm high O8 Strike box
 O9 Glass height (type S) O10 Glass height (type N) O11 Hinge datum line to DIN 18 268 O12 Finished floor level (FFL)

STUDIO Medio

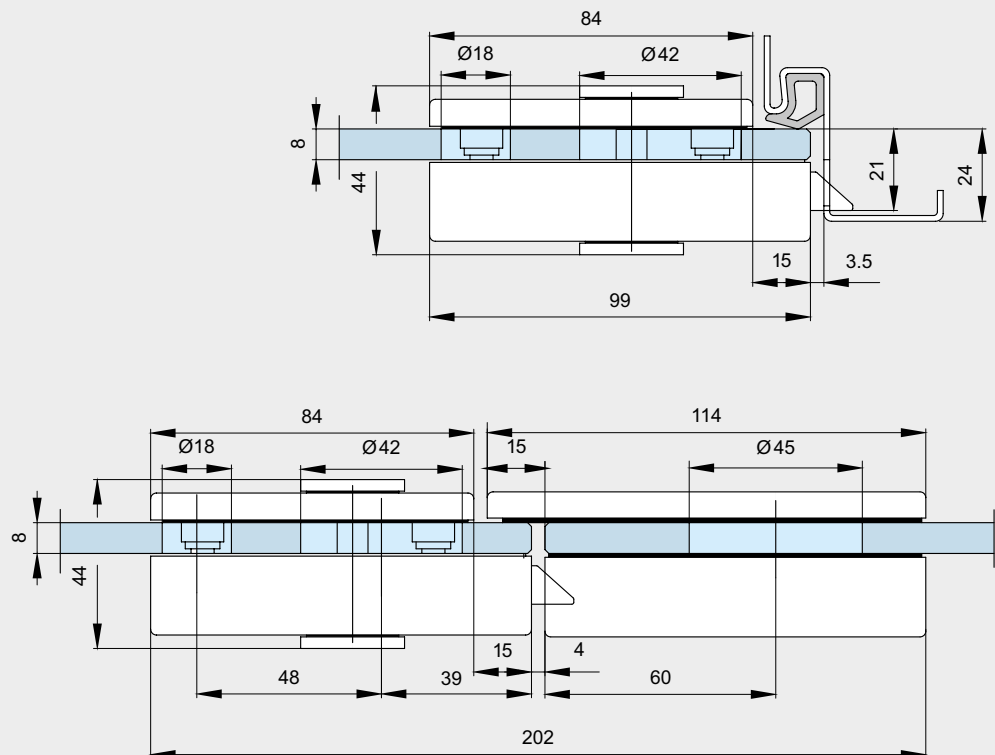

STUDIO Rondo
(STUDIO Classic, STUDIO Gala 2.0)

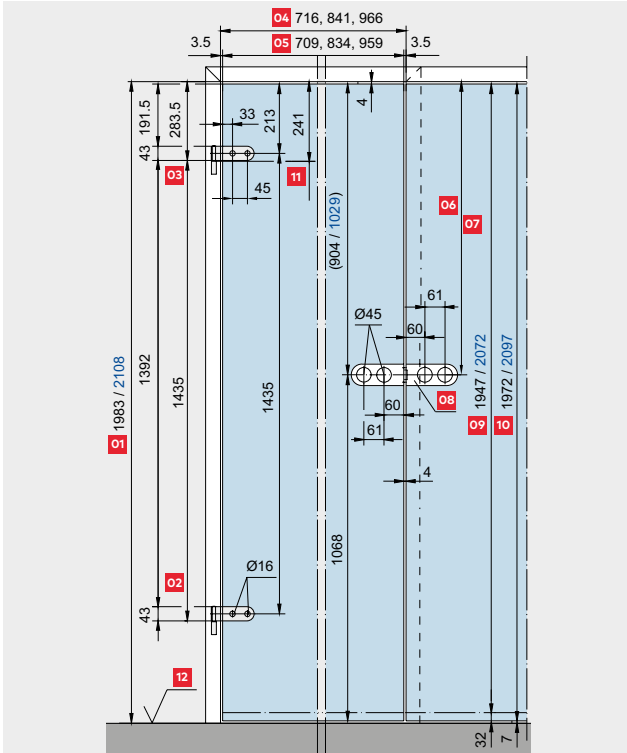

STUDIO Arcos

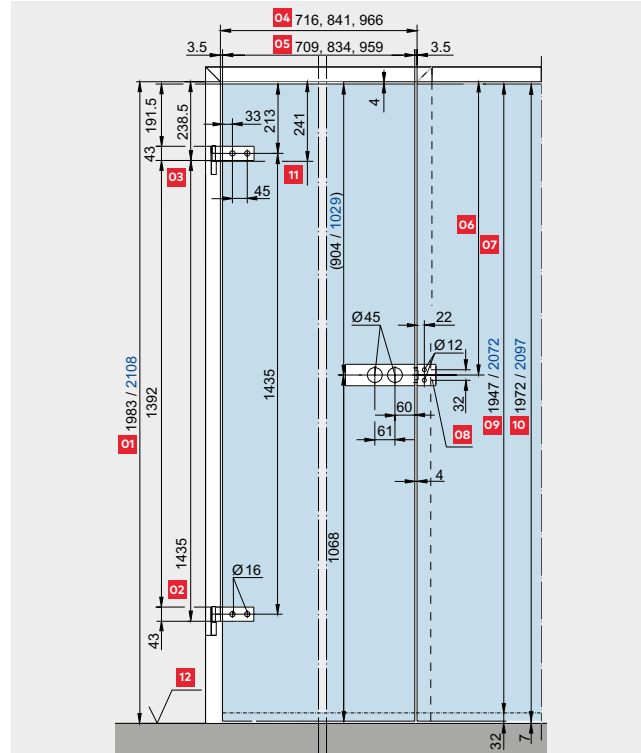

- O1 Frame rebate height O2 Standard hinge support to DIN 18 111 O3 Standard hinge support O4 Frame rebate width
- O5 Glass width O6 Centre lock bolt O7 Usually 908 / 1033 mm for doors 1972 / 2108 mm high O8 Strike box
- O9 Glass height (type S) O10 Glass height (type N) O11 Hinge datum line to DIN 18 268 O12 Finished floor level (FFL)

STUDIO Rondo
(STUDIO Classic,
STUDIO Gala 2.0)

X = 51er PZ

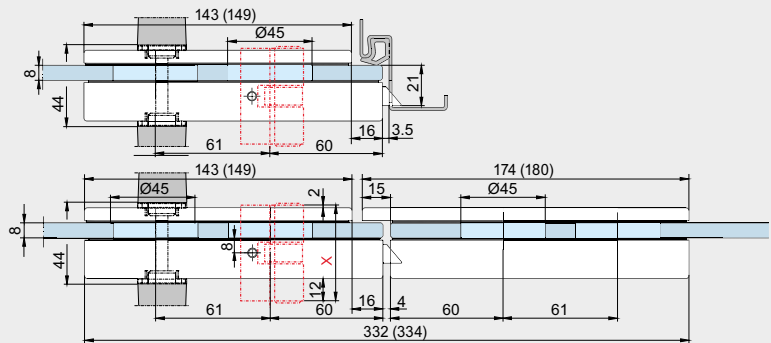
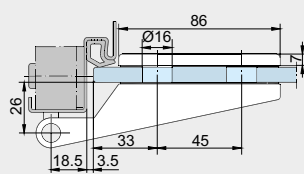

STUDIO Arcos

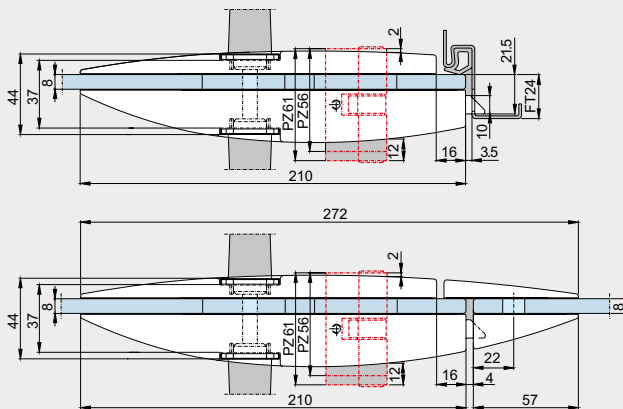
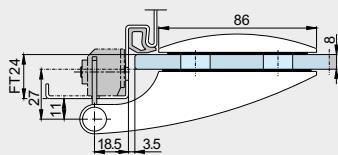

Frame pivots for steel frames

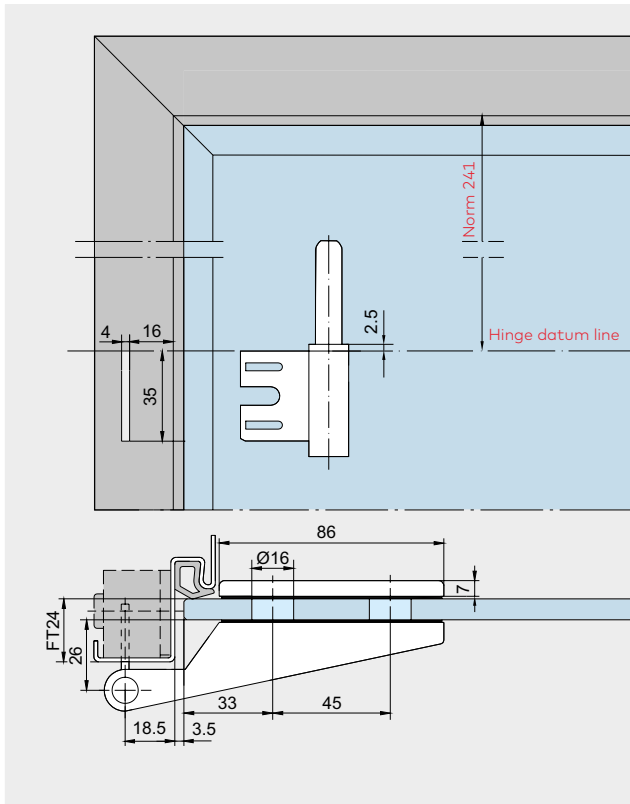

Frame pivots for wooden frames

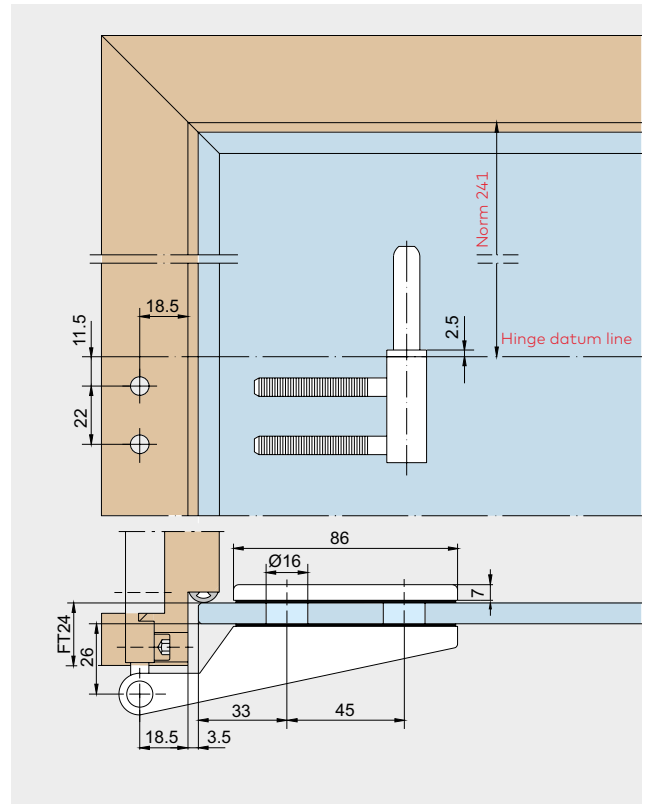

Screw on frame pivot

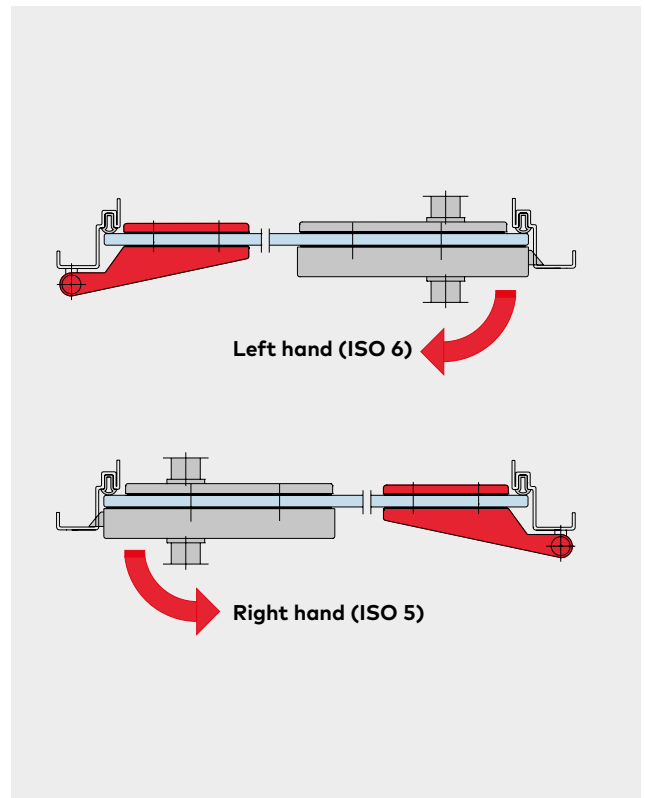
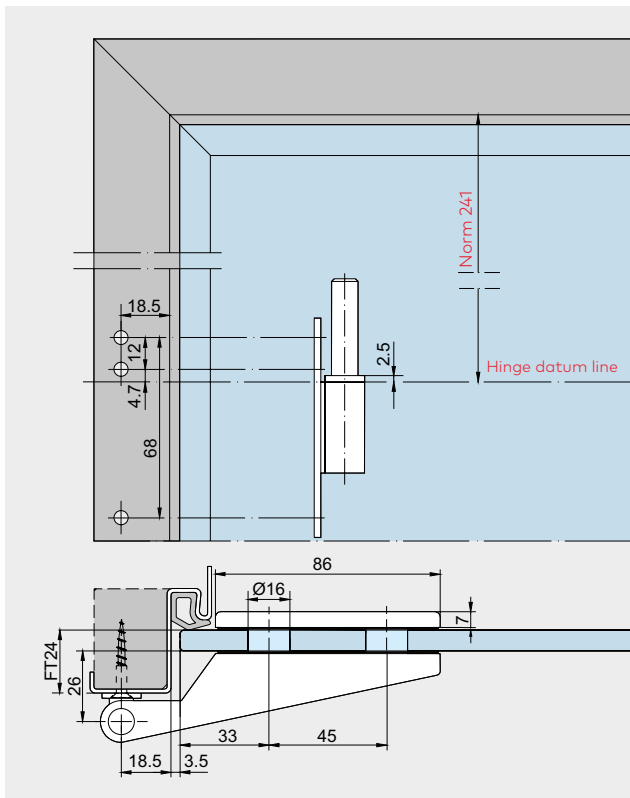

Space for your notes

Content

OFFICE Junior

62	Technical features
62	Components
88	Type illustrations
100	Accessories
114	Range of levers
169	Safety-related information



OFFICE Junior

Technical features

- Lock insert with low-noise "whisper" functionality as standard. The whisper latch (study metal latch – partially plastics-sheathed and damped latch motions for noise minimisation) satisfy particularly high expectations, including the requirements of government agencies and public authorities.
- Adjustable lever handle follower (+ / - 1°), patent pending, for avoidance of "lever handle sag" (droop). Further on a special spring supported clamp follower holds the lever handle perfectly secure.
- Locks comply to the current DIN EN 12209. They are designed for use in public buildings.
- Moreover these locks were tested successfully by a neutral testing institute with 500,000 latch and 100,000 locking bolt operating cycles.
- Special versions of the fitting manufactured in high-grade corrosion-resistant materials are available for wet room applications.

Locks for levers with roses

Complying to the current DIN EN 12209 (see page 6).

Locks supplied as standard for 8 mm glass thickness / 24 mm rebate depth, 10 mm glass thickness / 26 mm rebate depth resp. Extension plates are available for deeper rebates. Please contact our Application Engineering people for advice.

Hinges page 65 (also to suit doors with no over-rebate and rebate depth 25 – 40 mm)

	Product description	Art. No.
	<p>Lock prepared for Europrofile cylinder, nightlatch function, extended colour options, also available stainless steel</p> <p>Weight in kg: Aluminum 1.214 Stainless steel 1.505</p>	<p>11.200 L 11.201 R (not illustr.)</p>
	<p>Lock prepared for Europrofile cylinder, nightlatch function, lock corrosion-resistant</p> <p>Weight in kg: Aluminum 1.230</p>	<p>11.210 L 11.211 R (not illustr.)</p>
	<p>Lock non-locking, extended colours options, also available in stainless steel</p> <p>Weight in kg: Aluminum 1.210</p>	<p>11.212 L 11.213 R (not illustr.)</p>

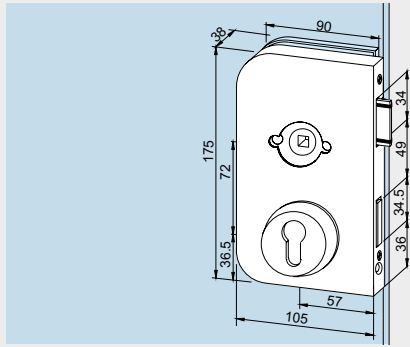
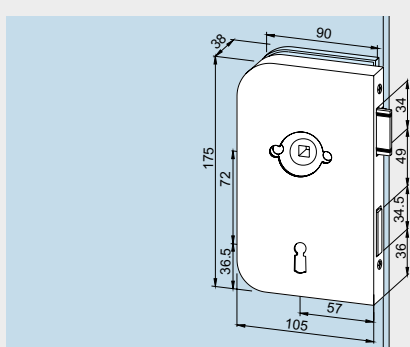
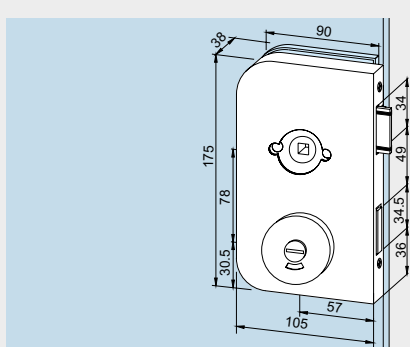
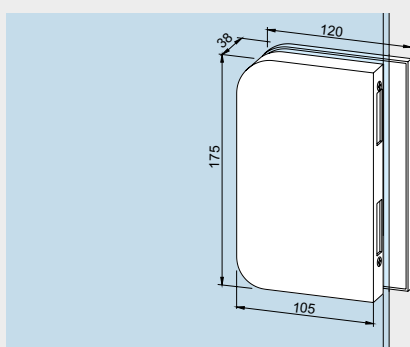
	Product description	Art. No.
	<p>Lock prepared for Europrofile cylinder, nightlatch function, cylinder rose on lock side, extended colour options</p> <p>Weight in kg: Aluminum 1.200</p> <p>Lock prepared for Europrofile cylinder, nightlatch function, cylinder roses on both sides, extended colour options,</p> <p>Weight in kg: Aluminum 1.214</p>	<p>11.242 L 11.243 R (not illustr.)</p> <p>11.228 L 11.229 R (not illustr.)</p>
	<p>Lock lever lock, without nightlatch function, 2 keys supplied, also available in stainless steel</p> <p>Weight in kg: Aluminum 1.115 Stainless steel 1.383</p> <p>Lock prepared for round profile cylinder, nightlatch function</p> <p>Weight in kg: Aluminum 1.075</p>	<p>11.202 L 11.203 R (not illustr.)</p> <p>11.240 L 11.241 R (not illustr.)</p>
	<p>Lock bathroom lock function</p> <p>Weight in kg: Aluminum 1.040</p> <p>Lock bathroom lock function, lock corrosion resistant</p> <p>Weight in kg: Aluminum 1.210</p>	<p>11.204 L 11.205 R (not illustr.)</p> <p>11.214 L 11.215 R (not illustr.)</p>
	<p>Strike box for OFFICE Junior locks, extended colour options</p> <p>Weight in kg: Aluminum 1.019 Stainless steel 1.335</p>	<p>11.206 L 11.207 R (not illustr.)</p>

Locks with follower

Complying to the current DIN EN 12209 (see page 6).

Locks supplied as standard for 8 mm glass thickness / 24 mm rebate depth, 10 mm glass thickness / 26 mm rebate depth resp.

Prepared for all levers without roses with 8 mm square spindles, spindle length for 44 mm lock thickness and 18 mm Ø follower, max. 8 mm long.
Hinges page 65 (also to suit doors with no over-rebate and rebate depth 25 – 40 mm)

	Product description	Art. No.
	<p>Lock prepared for Europrofile cylinder, nightlatch function, extended colour options, also available stainless steel</p> <p>Weight in kg: Aluminum 1.165 Stainless steel 1.445</p>	<p>11.260 L 11.261 R (not illustr.)</p>
	<p>Lock lever lock, without nightlatch function, 2 keys supplied, also available in stainless steel</p> <p>Weight in kg: Aluminum 1.115 Stainless steel 1.383</p>	<p>11.262 L 11.263 R (not illustr.)</p>
	<p>Lock prepared for round profile cylinder, with nightlatch function, 2 keys supplied, also available in stainless steel</p> <p>Weight in kg: Aluminum 1.113 Stainless steel 13.78</p>	<p>11.266 L 11.267 R (not illustr.)</p>
	<p>Lock non-locking, also available in stainless steel</p> <p>Weight in kg: Aluminum 1.040 Stainless steel 1.290</p>	<p>11.264 L 11.265 R (not illustr.)</p>
	<p>Strike box for OFFICE Junior locks, extended colour options</p> <p>Weight in kg: Aluminum 0.945 Stainless steel 1.335</p>	<p>11.206 L 11.207 R (not illustr.)</p>

Hinges for frame pivots

For 8 mm glass thickness / 24 mm rebate depth, 10 mm glass thickness / 26 mm rebate depth resp., max. door width 1,000 mm.

	Product description	Art. No.
	<p>Hinge for frame pivot complete with sleeve, zinc plated steel pin, door weight max. 80 kg</p> <p>Weight in kg: Aluminum 0.358</p>	11.230*
	<p>Hinge for frame pivot complete with sleeve, stainless steel pin, to be used in damp environments, door weight max. 80 kg</p> <p>Weight in kg: Aluminum 0.360</p>	11.237
	<p>Hinge for frame pivot complete with sleeve, to suit rebate depth 25 – 39 mm, door weight max. 70 kg,</p> <p>Weight in kg: Aluminum 0.530</p>	11.245 (not illustr.)
	<p>Hinge for frame pivot complete with sleeve, to suit rebate depth 40 mm, door weight max. 70 kg</p> <p>Weight in kg: Aluminum 1.111</p> <p>* Finish satin stainless steel (Niro S 700 ST) (700), not usable with screw-on frame pivot 11.405 (page 103).</p>	11.238

Hinges for frame pivots

	Product description	Glass thickness	Art. No.
	<p>Hinge for project doors with 160 mm type frame portion (reception element for example VN 7608/160 3D or VZK 060-1/3, or equivalent – not included in scope of delivery), stainless steel pin, plastic slide bearing door weight max. 70 kg, door width max. 1,200 mm</p> <p>Note: Consider separate frame processing</p> <p>do. for 40 mm rebate depth door weight max. 45 kg</p> <p>Weight in kg: Aluminum 0.519</p> <p>Note: Consider separate frame processing</p>		<p>11.233</p> <p>11.340 (not illustr.)</p>
	<p>Hinge with frame pivot for wooden frames, hinge flap for mortising into frame, zinc plated steel pin, plastic bushing, door weight max. 60 kg, door width max. 1,000 mm</p> <p>Weight in kg: Aluminum 0.425</p>		<p>11.239</p>
	<p>Hinge with frame pivot for non-rebated frames, hinge flap for screwing onto frame, stainless steel pin, plastic bushing, door weight max. 55 kg, door width max. 1,000 mm</p> <p>Weight in kg: Aluminum 0.205</p>	<p>8 mm 10 mm</p>	<p>12.090</p>

Space for your notes

Content

OFFICE Classic

70	Technical features
70	Components
88	Type illustrations
100	Accessories
114	Range of levers
169	Safety-related information



OFFICE Classic

Technical features

- Lock insert with low-noise "whisper" functionality as standard. The whisper latch (study metal latch – partially plastics-sheathed and damped latch motions for noise minimisation) satisfy particularly high expectations, including the requirements of government agencies and public authorities.
- Adjustable lever handle follower (+ / - 1°), patent pending, for avoidance of "lever handle sag" (droop). Further on a special spring supported clamp follower holds the lever handle perfectly secure.
- Locks comply to the current DIN EN 12209. They are designed for use in public buildings.
- Moreover these locks were tested successfully by a neutral testing institute with 500,000 latch and 100,000 locking bolt operating cycles.
- Special versions of the fitting manufactured in high-grade corrosion-resistant materials are available for wet room applications.

Locks for levers with roses

Complying to the current DIN EN 12209 (see page 6).

Locks supplied as standard for 8 mm glass thickness / 24 mm rebate depth, 10 mm glass thickness / 26 mm rebate depth resp.

Hinges page 73 (also to suit doors with no over-rebate and rebate depth 25 – 40 mm)

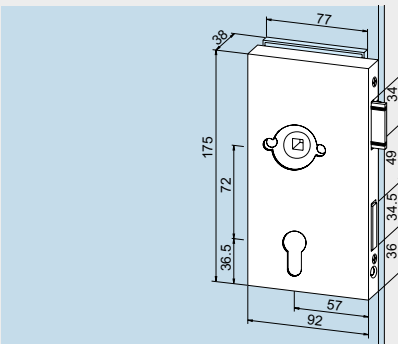
	Product description	Art. No.
	<p>Lock prepared for Europrofile cylinder, nightlatch function</p> <p>Weight in kg: Aluminum 1.165</p>	<p>11.270 L 11.271 R (not illustr.)</p>

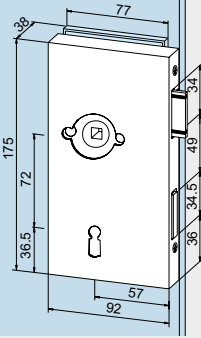
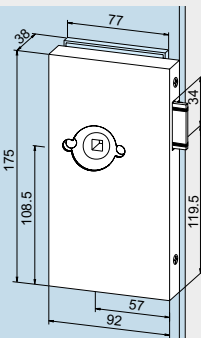
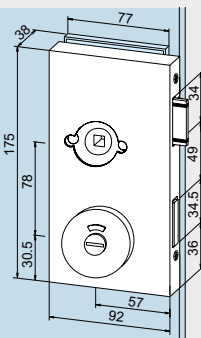
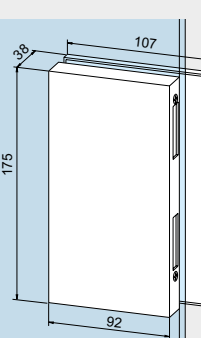
	Product description	Art. No.
	<p>Lock warded key, without nightlatch function, 2 keys supplied</p> <p>Weight in kg: Aluminum 1.115</p>	<p>11.272 L 11.273 R (not illustr.)</p>
	<p>Lock non-locking</p> <p>Weight in kg: Aluminum 1.040</p>	<p>11.274 L 11.275 R (not illustr.)</p>
	<p>Lock bathroom lock function</p> <p>Weight in kg: Aluminum 1.040</p>	<p>11.276 L 11.277 R (not illustr.)</p>
	<p>Strike box for OFFICE Classic locks</p> <p>Weight in kg: Aluminum 0.945</p>	<p>11.286 L 11.287 R (not illustr.)</p>

Locks with follower

Complying to the current DIN EN 12209 (see page 6).

Locks supplied as standard for 8 mm glass thickness / 24 mm rebate depth, 10 mm glass thickness / 26 mm rebate depth resp.

Prepared for all levers without roses with 8 mm square spindles, spindle length for 44 mm lock thickness and 18 mm Ø follower, max. 8 mm long.
Hinges page 73 (also to suit doors with no over-rebate and rebate depth 25 – 40 mm).

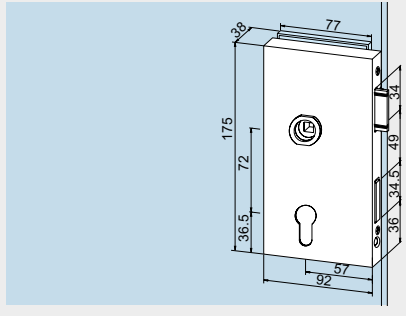
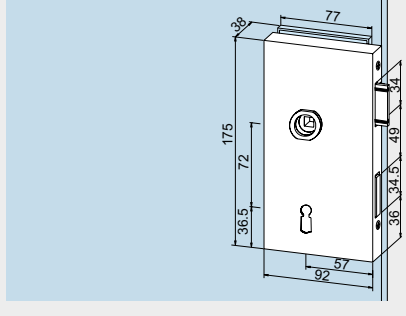
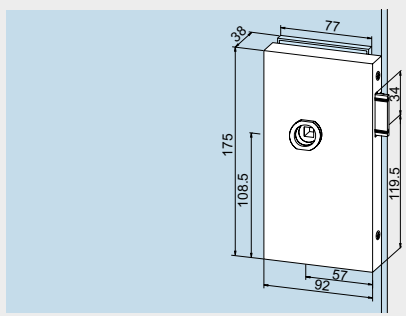
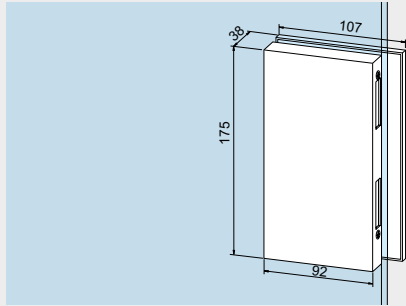
	Product description	Art. No.
	<p>Lock prepared for Europrofile cylinder, nightlatch function</p> <p>Weight in kg: Aluminum 1.165</p>	<p>11.280 L 11.281 R (not illustr.)</p>
	<p>Lock lever lock, without nightlatch function, 2 keys supplied</p> <p>Weight in kg: Aluminum 1.115</p> <p>Lock prepared for KABA, with nightlatch function, 2 keys supplied</p> <p>Weight in kg: Aluminum 1.113</p>	<p>11.282 L 11.283 R (not illustr.)</p> <p>11.320 L 11.321 R (not illustr.)</p>
	<p>Lock non-locking</p> <p>Weight in kg: Aluminum 1.040</p>	<p>11.284 L 11.285 R (not illustr.)</p>
	<p>Strike box for OFFICE Classic locks</p> <p>Weight in kg: Aluminum 0.945</p>	<p>11.286 L 11.287 R (not illustr.)</p>

Hinges for frame pivots

For 8 mm glass thickness / 24 mm rebate depth, 10 mm glass thickness / 26 mm rebate depth resp., max. door width 1,000 mm.

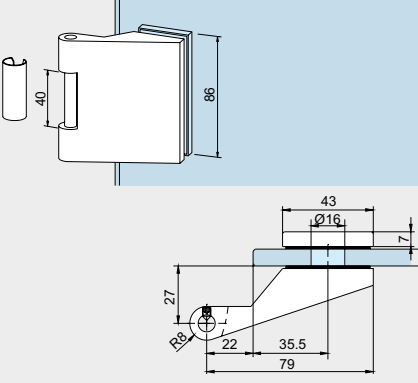
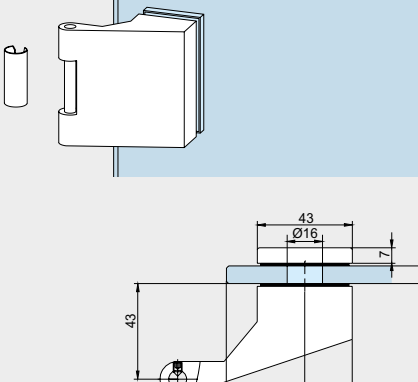
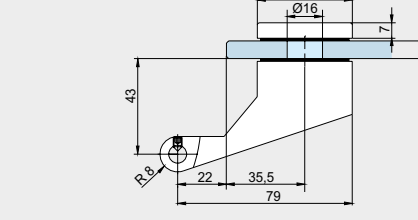
	Product description	Art. No.
	<p>Hinge for frame pivot complete with sleeve, zinc plated steel pin, door weight max. 80 kg</p> <p>Weight in kg: Aluminum 0.358</p>	11.288
	<p>Hinge for frame pivot complete with sleeve, to suit rebate depth 40 mm, door weight max. 70 kg</p> <p>Weight in kg: Aluminum 1.111</p>	11.295
	<p>Hinge for frame pivot complete with sleeve, to suit rebate depth 25-39 mm, door weight max. 70 kg</p> <p>Weight in kg: Aluminum 0,530</p>	11.297

Hinges with frame pivots

For 8 mm glass thickness / 24 mm rebate depth, 10 mm glass thickness / 26 mm rebate depth resp., max. door width 1,000 mm.

	Product description	Glass thickness	Art. No.
	<p>Hinge for project doors with 160 mm type frame portion (reception element for example VN 7608/160 3D or VZK 060-1/3, or equivalent – not included in scope of delivery), stainless steel pin, plastic slide bearing, door weight max. 70 kg, door width max. 1,200 mm</p> <p>do. for 40 mm rebate depth, door weight max. 45 kg</p> <p>Weight in kg: Aluminum 0.519</p>		<p>11.291</p> <p>11.341 (not illustr.)</p>
	<p>Hinge with frame pivot for wooden frames, hinge flap for mortising into frame, zinc plated steel pin, plastic bushing, door weight max. 60 kg, door width max. 1,000 mm</p> <p>Weight in kg: Aluminum 0.425</p>		<p>11.342</p>
	<p>Hinge with frame pivot for non-rebated frames, hinge flap for screwing onto frame, stainless steel pin, plastic bushing, door weight max. 55 kg, door width max. 1,000 mm</p> <p>Weight in kg: Aluminum 0.230</p>	<p>8 mm 10 mm</p>	<p>12.091</p>

Space for your notes

Content

OFFICE Mundus

78	Technical features
78	Components
88	Type illustrations
100	Accessories
114	Range of levers
169	Safety-related information



OFFICE Mundus

Technical features

- Lock insert with low-noise "whisper" functionality as standard. The whisper latch (study metal latch – partially plastics-sheathed and damped latch motions for noise minimisation) satisfy particularly high expectations, including the requirements of government agencies and public authorities.
- Adjustable lever handle follower (+ / - 1°), patent pending, for avoidance of "lever handle sag" (droop). Further on a special spring supported clamp follower holds the lever handle perfectly secure.
- Locks comply to the current DIN EN 12209. They are designed for use in public buildings.
- Moreover these locks were tested successfully by a neutral testing institute with 500,000 latch and 100,000 locking bolt operating cycles.
- Special versions of the fitting manufactured in high-grade corrosion-resistant materials are available for wet room applications.

Locks for levers with roses

Complying to the current DIN EN 12209 (see page 6).

Locks supplied as standard for 8 mm glass thickness / 24 mm rebate depth, 10 mm glass thickness / 26 mm rebate depth resp.
Hinges page 73 (also to suit doors with no over-rebate and rebate depth 25 – 40 mm)

	Product description	Art. No.
	<p>Lock prepared for Europrofile cylinder, nightlatch function</p> <p>Weight in kg: Aluminum 0.730 Stainless steel 1.120</p>	<p>11.842 L 11.843 R (not illustr.)</p>
	<p>Lock non-locking</p> <p>Weight in kg: Aluminum 0.800 Stainless steel 1.150</p>	<p>11.844 L 11.845 R (not illustr.)</p>
	<p>Strike box for OFFICE Mundus locks</p> <p>Weight in kg: Aluminum 0.570 Stainless steel 0.810</p>	<p>11.848 L 11.849 R (not illustr.)</p>

Locks with follower

Complying to the current DIN EN 12209 (see page 6).

Locks supplied as standard for 8 mm glass thickness / 24 mm rebate depth, 10 mm glass thickness / 26 mm rebate depth resp.

Prepared for all levers without roses with 8 mm square spindles, spindle length for 44 mm lock thickness and 18 mm \varnothing follower, max. 8 mm long.
Hinges page 73 (also to suit doors with no over-rebate and rebate depth 25 – 40 mm).

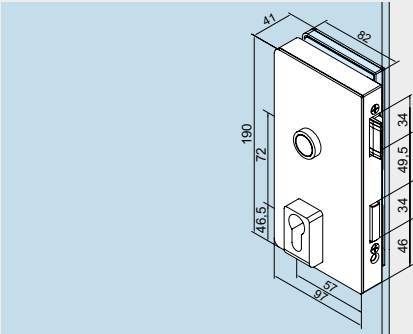
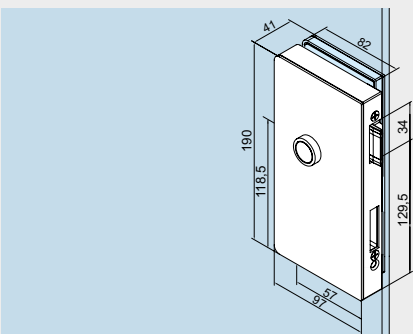
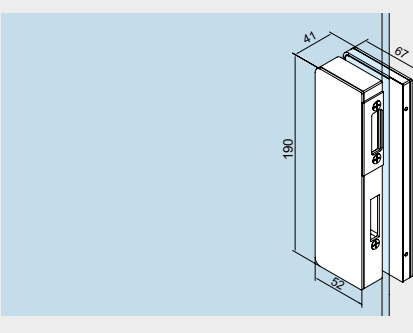
	Product description	Art. No.
	<p>Lock prepared for Europrofile cylinder, nightlatch function</p> <p>Weight in kg: Aluminum 0.830 Stainless steel 1.240</p>	<p>11.838 L 11.839 R (not illustr.)</p>
	<p>Lock non-locking</p> <p>Weight in kg: Aluminum 0.800 Stainless steel 1.150</p>	<p>11.840 L 11.841 R (not illustr.)</p>
	<p>Strike box for OFFICE Mundus locks</p> <p>Weight in kg: Aluminum 0.570 Stainless steel 0.810</p>	<p>11.848 L 11.849 R (not illustr.)</p>
	<p>Set follower for 16 mm diameter</p>	<p>11.852 (not illustr.)</p>

Hinges for frame pivots

For 8 mm glass thickness / 24 mm rebate depth, 10 mm glass thickness / 26 mm rebate depth resp., max. door width 1,000 mm.

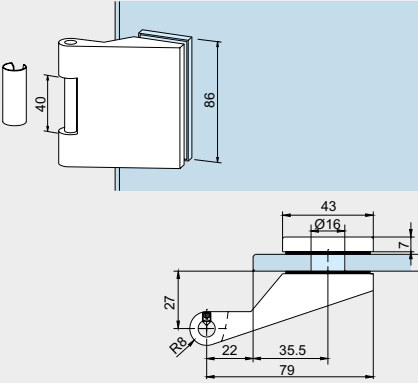
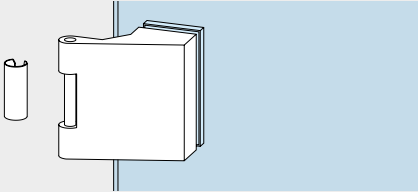
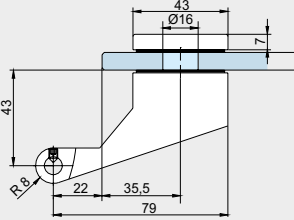
	Product description	Art. No.
	<p>Hinge for frame pivot complete with sleeve, zinc plated steel pin, door weight max. 80 kg</p> <p>Weight in kg: Aluminum 0.358</p>	<p>11.288</p>
	<p>Hinge for frame pivot complete with sleeve, to suit rebate depth 40 mm, door weight max. 70 kg</p> <p>Weight in kg: Aluminum 1.111</p>	<p>11.295</p>
	<p>Hinge for frame pivot complete with sleeve, to suit rebate depth 25-39 mm, door weight max. 70 kg</p> <p>Weight in kg: Aluminum 0,530</p>	<p>11.297</p>

Hinges with frame pivots

For 8 mm glass thickness / 24 mm rebate depth, 10 mm glass thickness / 26 mm rebate depth resp., max. door width 1,000 mm.

	Product description	Glass thickness	Art. No.
	<p>Hinge for project doors with 160 mm type VN frame portion (reception element for example VN 7608/160 3D or VZK 060-1/3, or equivalent – not included in scope of delivery), stainless steel pin, plastic slide bearing, door weight max. 70 kg, door width max. 1,200 mm</p> <p>do. for 40 mm rebate depth, door weight max. 45 kg</p> <p>Weight in kg: Aluminum 0.519</p>		<p>11.291</p> <p>11.341 (not illustr.)</p>
	<p>Hinge with frame pivot for wooden frames, hinge flap for mortising into frame, zinc plated steel pin, plastic bushing, door weight max. 60 kg, door width max. 1,000 mm</p> <p>Weight in kg: Aluminum 0.425</p>		<p>11.342</p>
	<p>Hinge with frame pivot for non-rebated frames, hinge flap for screwing onto frame, stainless steel pin, plastic bushing, door weight max. 55 kg, door width max. 1,000 mm</p> <p>Weight in kg: Aluminum 0.230</p>	<p>8 mm 10 mm</p>	<p>12.091</p>

Content

OFFICE Arcos

86	Components
87	Installation details
88	Type illustrations
100	Accessories
114	Range of levers
169	Safety-related information



OFFICE Arcos

Locks with follower

Complying to the current DIN EN 12209, successfully tested during extended type testing.

Locks supplied as standard for 8 mm glass thickness / 24 mm rebate depth, 10 mm glass thickness / 26 mm rebate depth resp..

- Lock insert with low-noise "whisper" functionality as standard. The whisper latch (study metal latch – partially plastics-sheathed and damped latch motions for noise minimisation) satisfy particularly high expectations, including the requirements of government agencies and public authorities.
- Adjustable lever handle follower (+ / – 1°), patent pending, for avoidance of "lever handle sag" (droop). Further on a special spring supported clamp follower holds the lever handle perfectly secure.
- The fully closed lock case provides optimum protection for the internal components which themselves are of rugged unit construction.
- Locks comply to the current DIN EN 12209. They are designed for use in public buildings.
- Moreover these locks were tested successfully by a neutral testing institute with 500,000 latch and 100,000 locking bolt operating cycles.
- Special versions of the fitting manufactured in high-grade corrosion-resistant materials are available for wet room applications.

Complying to the current DIN EN 12209, successfully tested during extended type testing.

Locks supplied as standard for 8 mm glass thickness / 24 mm rebate depth, 10 mm glass thickness / 26 mm rebate depth resp.

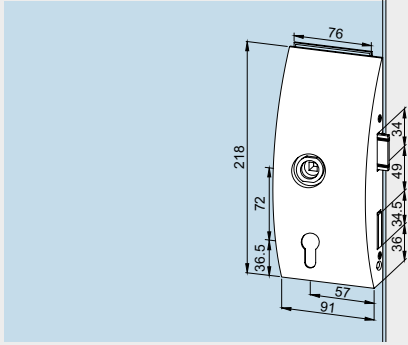
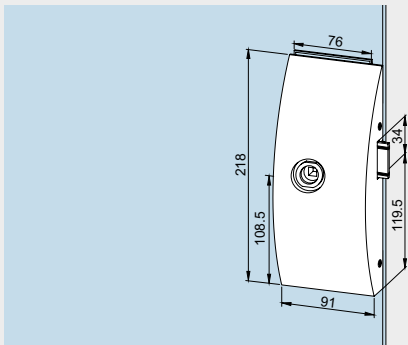
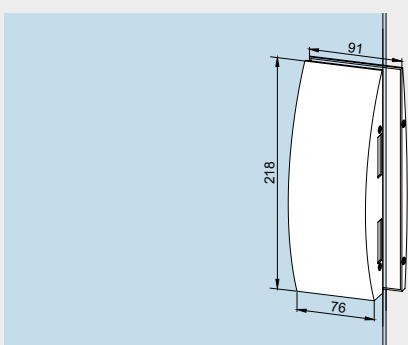
	Product description	Art. No.
	<p>Lock prepared for Europrofile cylinder, nightlatch function</p> <p>Weight in kg: Aluminum 1.165</p>	<p>25.260 L 25.261 R (not illustr.)</p>
	<p>Lock non-locking</p> <p>Weight in kg: Aluminum 1.040</p>	<p>25.264 L 25.265 R (not illustr.)</p>
	<p>Strike box for OFFICE Arcos locks, extended colour options</p> <p>Weight in kg: Aluminum 0.945</p>	<p>25.206 L 25.207 R (not illustr.)</p>

Hinges

For 8 mm glass thickness / 24 mm rebate depth, 10 mm glass thickness / 26 mm rebate depth resp., max. door width 1,000 mm.

	Product description	Art. No.
	<p>Hinge for frame pivot complete with sleeve, zinc plated steel pin, door weight max. 80 kg</p> <p>Weight in kg: Aluminum 0.358</p>	<p>25.230</p>
	<p>Hinge for frame pivot complete with sleeve, to suit rebate depth 40 mm, door weight max. 70 kg</p> <p>Weight in kg: Aluminum 1.111</p>	<p>25.238 (not illustr.)</p>

Installation details and sections for frame pivots

OFFICE Junior / Classic

OFFICE Arcos

OFFICE Mundus

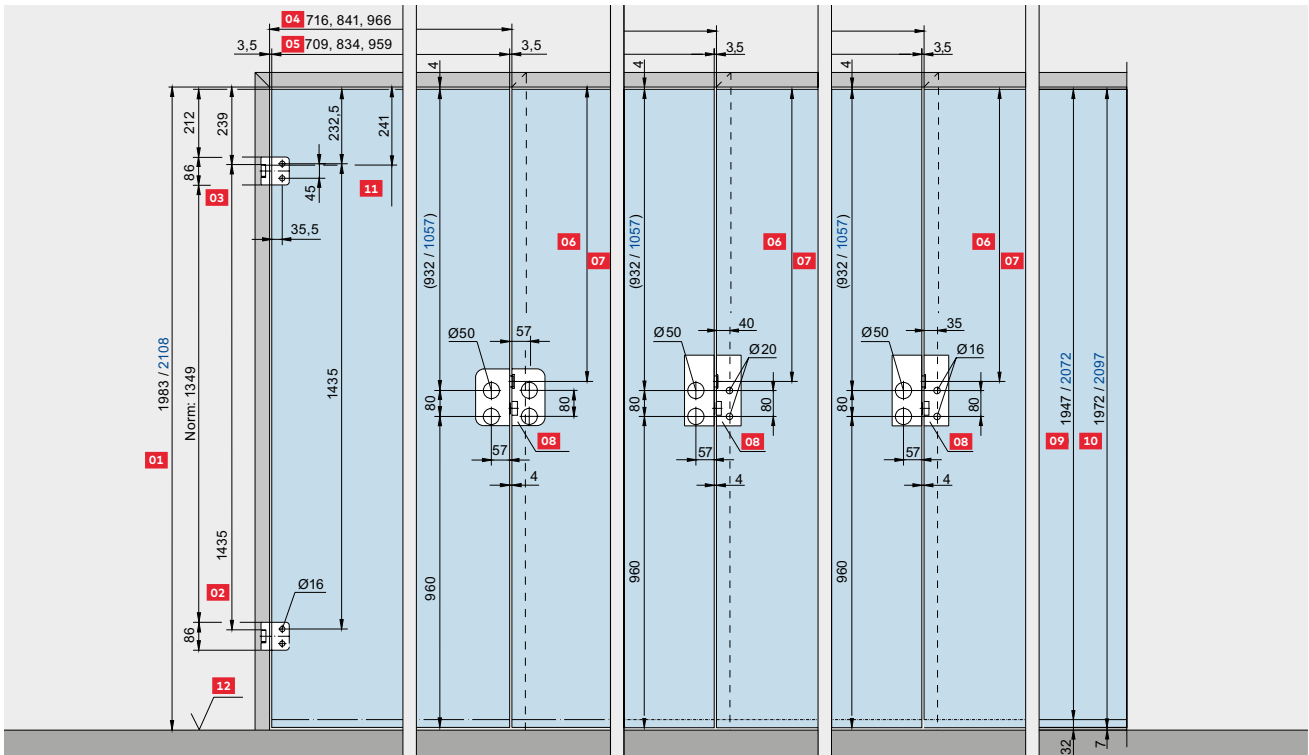

- 01** Frame rebate height
- 02** Standard hinge support to DIN 18 111
- 03** Standard hinge support
- 04** Frame rebate width
- 05** Glass width
- 06** Centre lock bolt
- 07** Usually 908 / 1033 mm for doors 1972 / 2108 high
- 08** Strike box
- 09** Glass height (type S)
- 10** Glass height (type N)
- 11** Hinge datum line to DIN 18 268
- 12** Finished floor level (FFL)

OFFICE Junior (OFFICE Classic)

X = 51er PZ

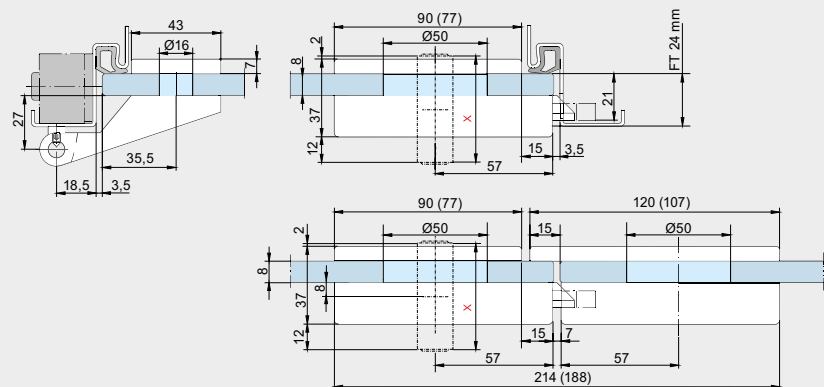

OFFICE Arcos 61 mm profile cylinder

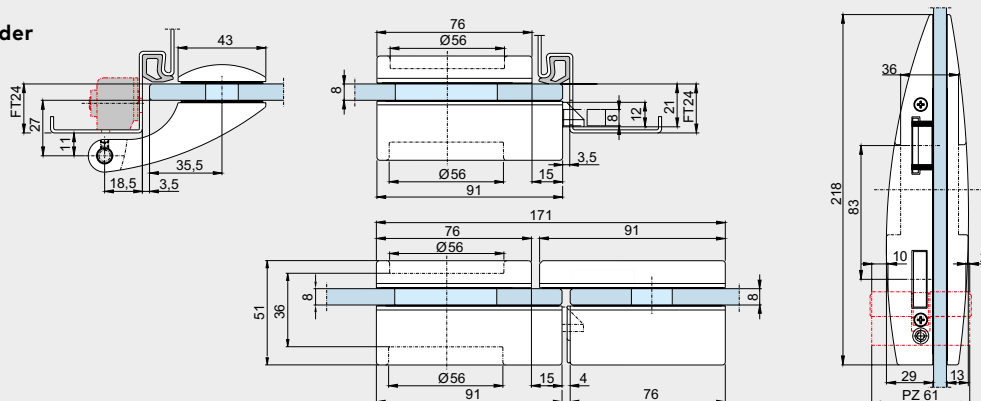

Frame pivots for steel frames

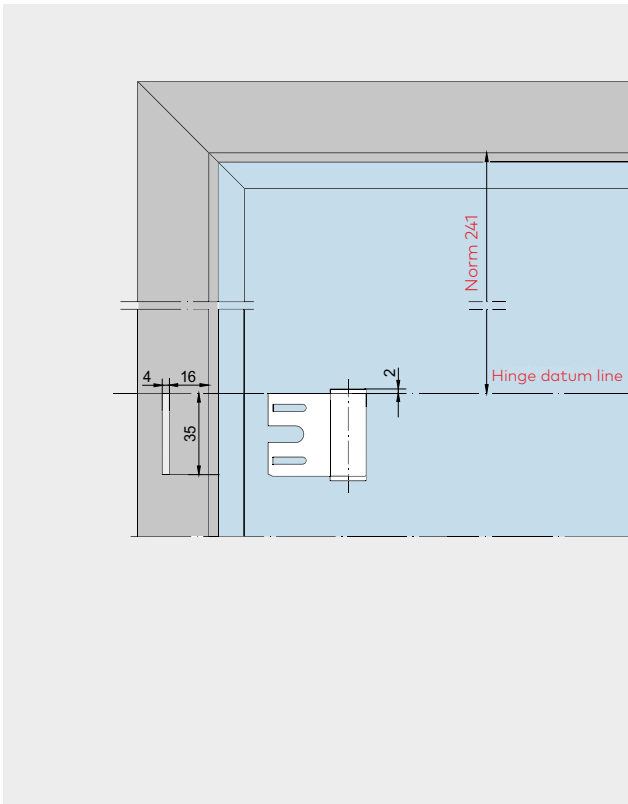

Frame pivots for wooden frames

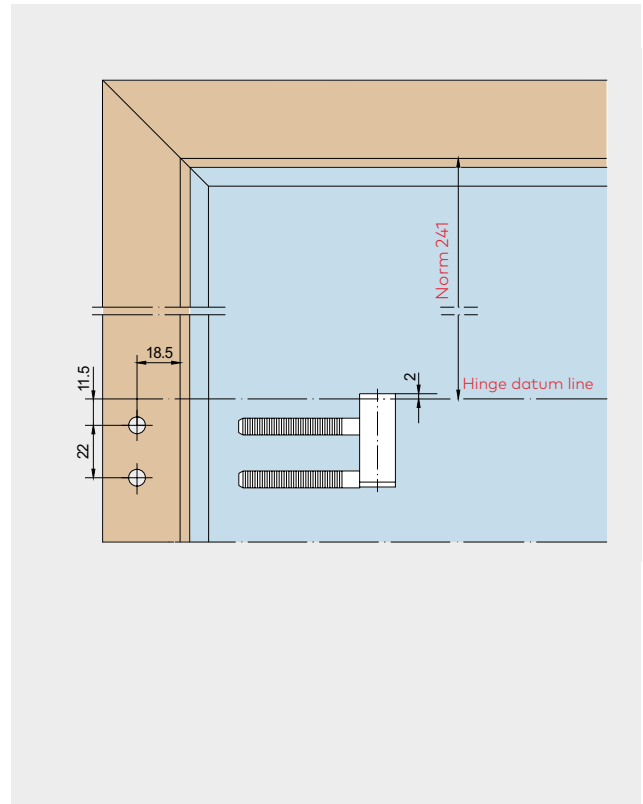

Screw on frame pivot

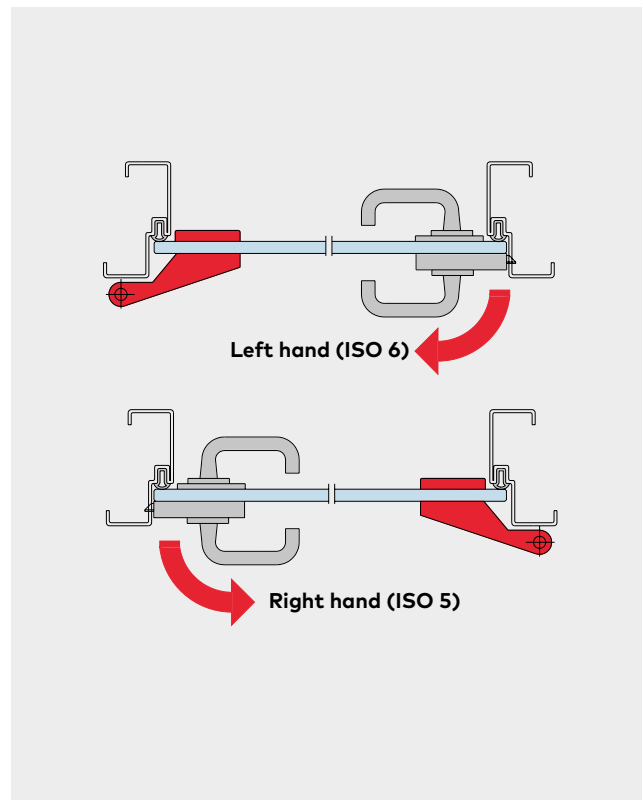
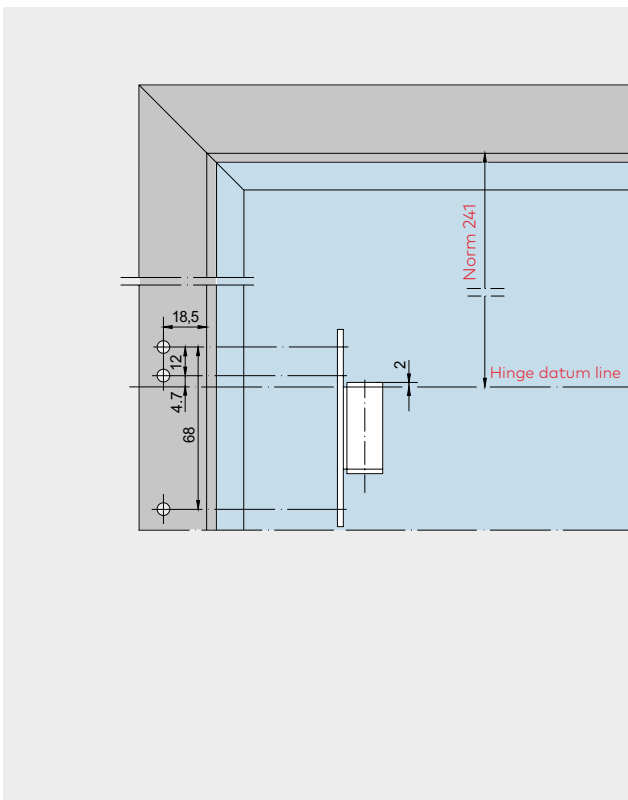

Frame pivot for frame pocket type VN 120 / type VX

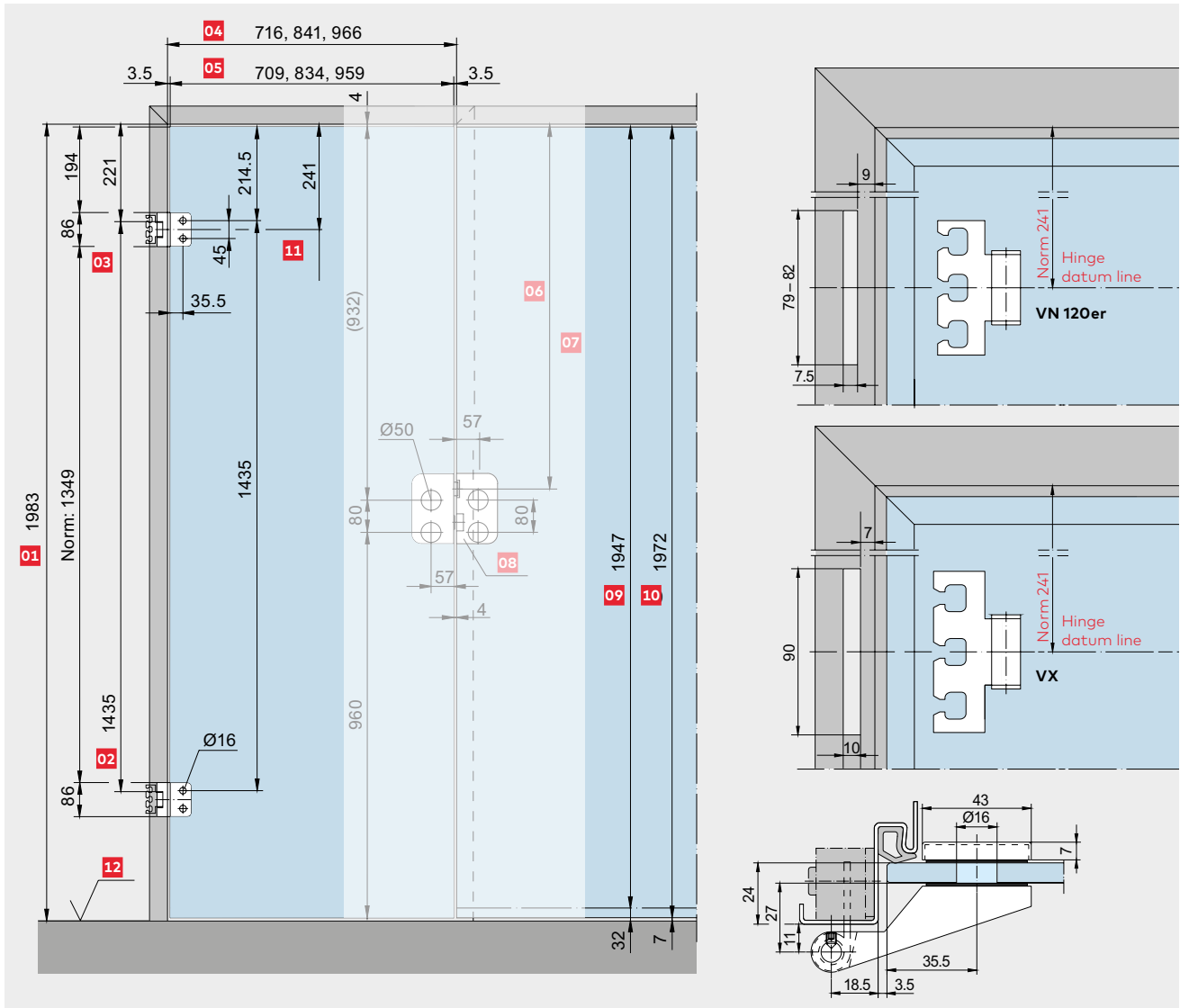

- | | | |
|---|---|---|
| 01
Frame rebate height | 05
Glass width | 09
Glass height (type S) |
| 02
Standard hinge support to DIN 18 111 | 06
Centre lock bolt | 10
Glass height (type N) |
| 03
Standard hinge support | 07
Usually 908 mm for doors 1,972 mm high | 11
Hinge datum line to DIN 18 268 |
| 04
Frame rebate width | 08
Strike box | 12
Finished floor level (FFL) |

Frame pivot for 160 mm type VN frame pocket

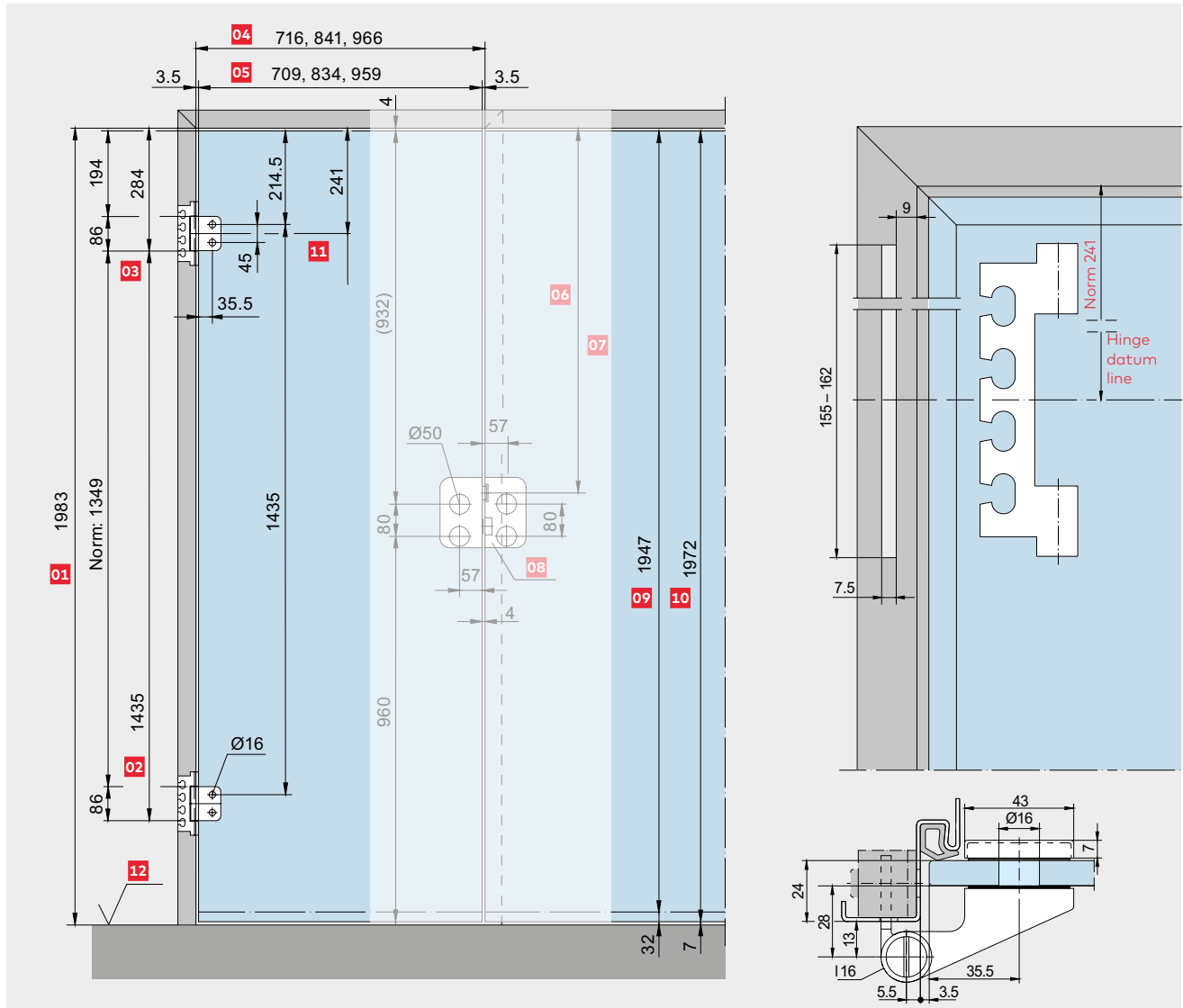

- | | | |
|---|---|---|
| 01
Frame rebate height | 05
Glass width | 09
Glass height (type S) |
| 02
Standard hinge support to DIN 18 111 | 06
Centre lock bolt | 10
Glass height (type N) |
| 03
Standard hinge support | 07
Usually 908 mm for doors 1,972 mm high | 11
Hinge datum line to DIN 18 268 |
| 04
Frame rebate width | 08
Strike box | 12
Finished floor level (FFL) |

Space for your notes

For frame pocket type VN 160

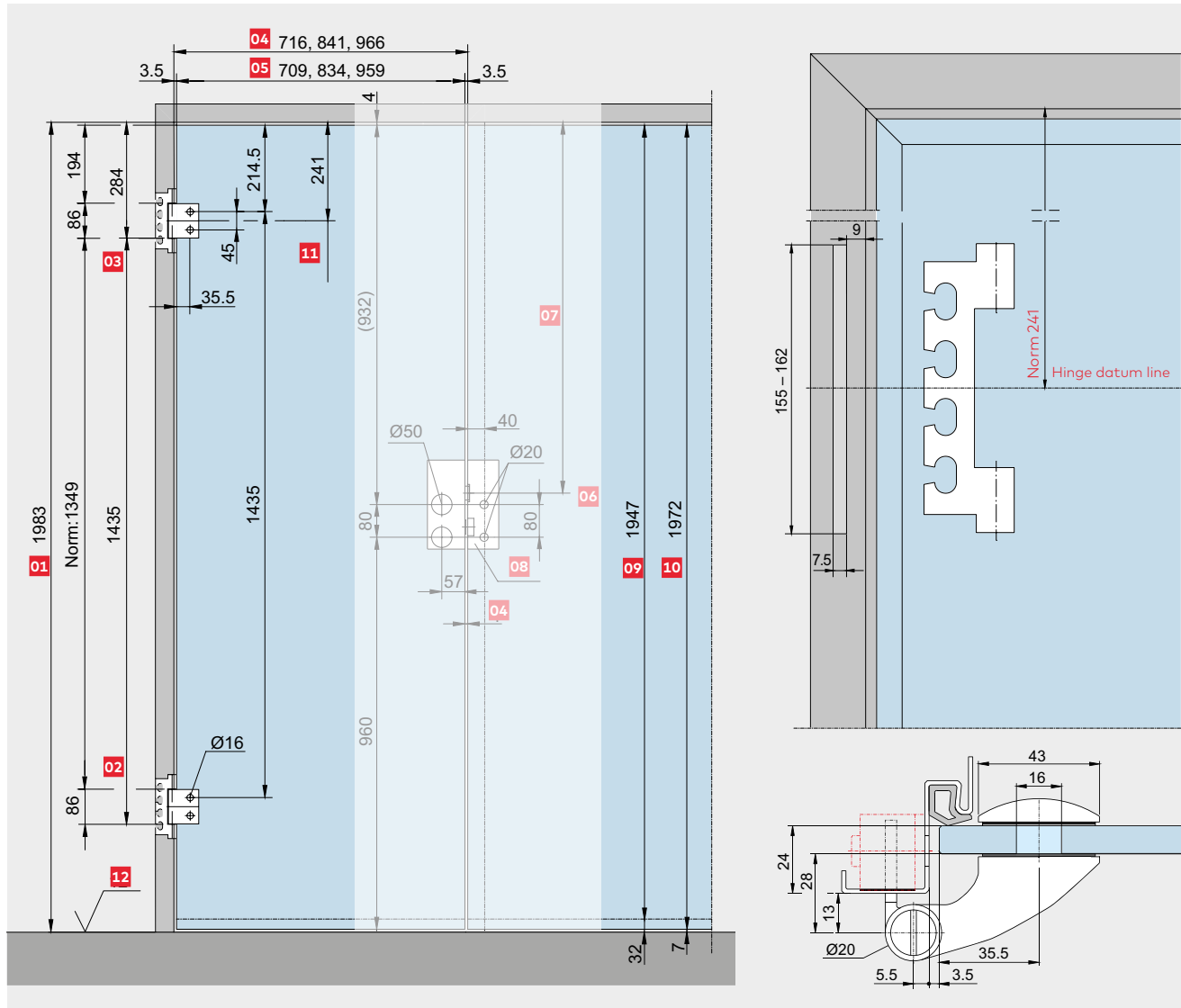

- | | | |
|---|---|---|
| 01
Frame rebate height | 05
Glass width | 09
Glass height (type S) |
| 02
Standard hinge support to DIN 18 111 | 06
Centre lock bolt | 10
Glass height (type N) |
| 03
Standard hinge support | 07
Usually 908 mm for doors 1,972 mm high | 11
Hinge datum line to DIN 18 268 |
| 04
Frame rebate width | 08
Strike box | 12
Finished floor level (FFL) |

Hinge reference lines according to DIN 18101

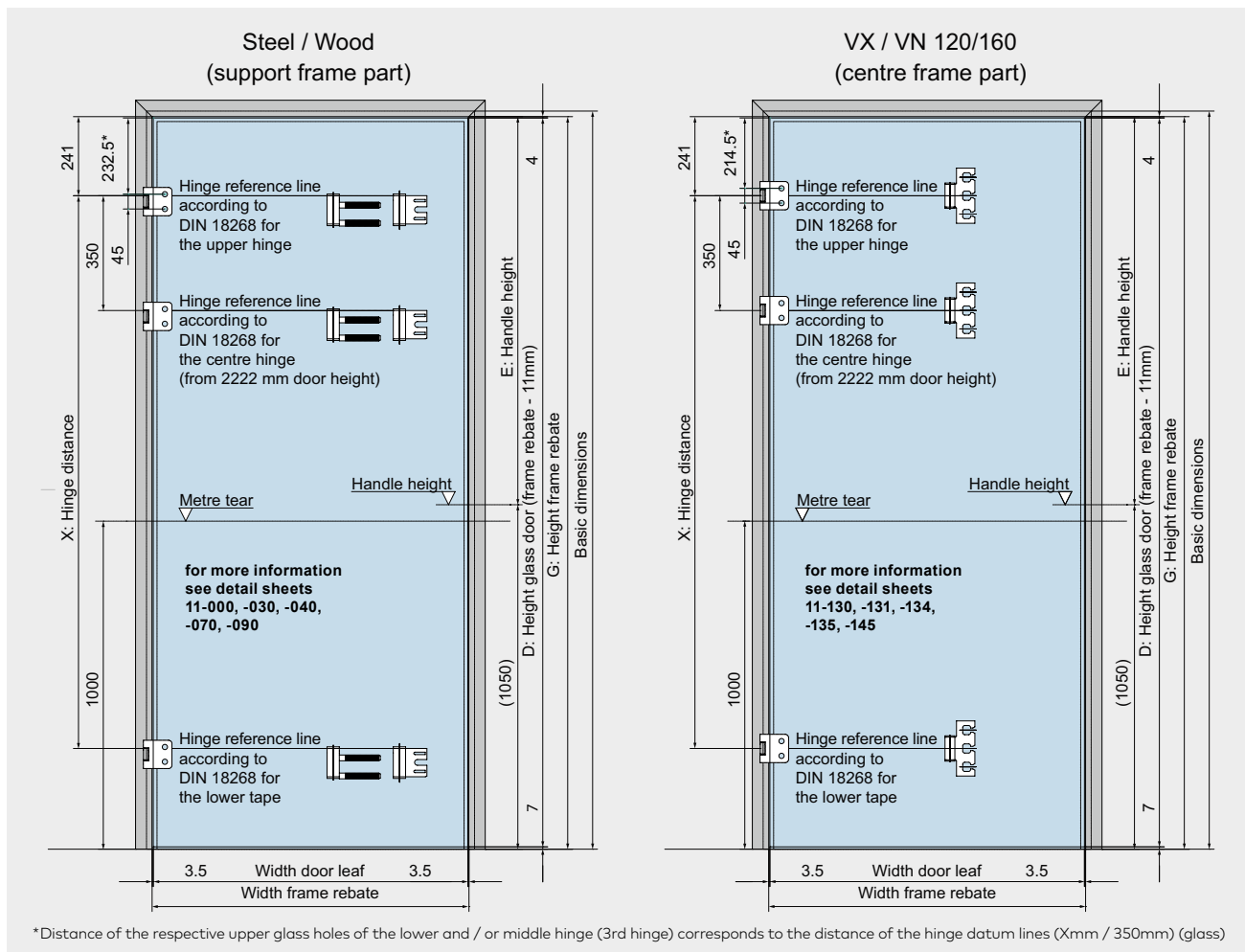

	Basic dimensions (wall opening) ^{*1}	Height door leaf	Width door leaf	Height frame rebate ^{*2}	Width frame rebate	Hinge reference line Hinge distance from upper to lower frame part to lower frame part	Handle height ^{*3}
		D		G		X	E
1	1625	1597		1608		1060	554
2	1750	1722		1733		1185	679
3	1875	1847		1858		1310	804
4	2000	1972		1983		1435	929
5	2125	2097	709, 834, 959, 1084	2108	716, 841, 966, 1091	1435	1054
6	2250	2222		2233		1685	1179
7	2375	2347		2358		1810	1304
8	2500	2472		2483		1935	1429
9	2625	2597		2608		2060	1554
10	2750	2722		2733		2185	1679

*1: To derive the nominal dimensions for wall openings from the basic dimensions, see DIN 4172 and DIN 18100.

*2: The clear frame height of frames without cross-over is approx. 10 mm to 15 mm less depending on the frame construction; the exact dimensions may be obtained from the manufacturer of the frame.

*3: This dimension results in a calculated handle height of 1,050 mm from the surface of the finished floor.

For dormakaba OFFICE toughened glass door fittings applies:

If doors according to DIN 18101 are to have a third hinge, the hinge reference line according to DIN 18268 for this hinge must be 350 mm below the hinge reference line of the uppermost hinge. This specification is binding for door heights from 2,222 mm, otherwise the warranty claim will expire. STUDIO door applications are not suitable for door heights greater than 1,997 mm, therefore the use of a third hinge in these applications is not recommended.

Content

Special hinges

96 **Components**

169 **Safety-related information**



Special hinges

Stainless steel hinge for internal glass doors

for 8 mm and 10 mm glass.

For 8 mm glass thickness / 24 mm rebate depth,
10 mm glass thickness / 26 mm rebate depth resp.,
max. door width 1,000 mm.

Hinges meet highest corrosion resistance
(EN 1670, class 4)

Versions with rounded angles also available
on request.

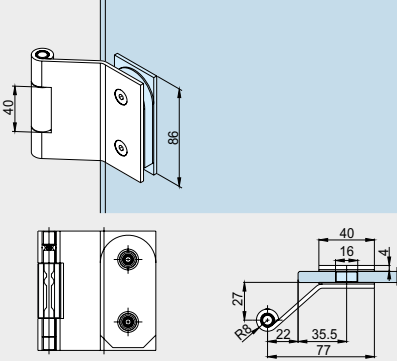
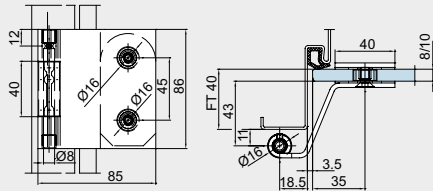
Product description	Art. No.	
	<p>Stainless steel hinge for frame pivot with stainless steel sleeve, stainless steel pin, door weight max. 80 kg</p> <p>Weight in kg: Stainless steel 0.332</p>	11.500
	<p>Stainless steel hinge for frame pivot for rebate depth 40 mm, with stainless steel sleeve, stainless steel pin, door weight max. 70 kg</p> <p>Weight in kg: Stainless steel 0.371</p> <p>Please note: Applications / glass preparation like OFFICE Classic (see page 87). Frame pivots on page 102.</p>	11.502

Hinges for 8 mm glass thickness

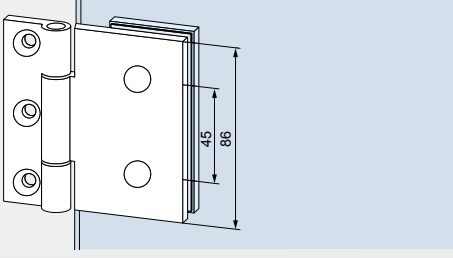
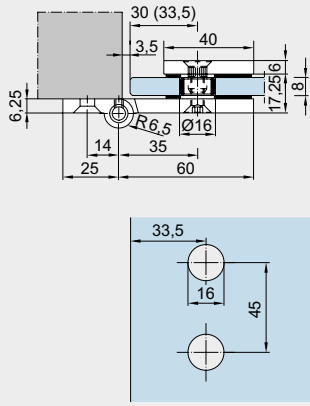
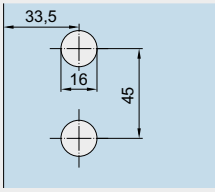
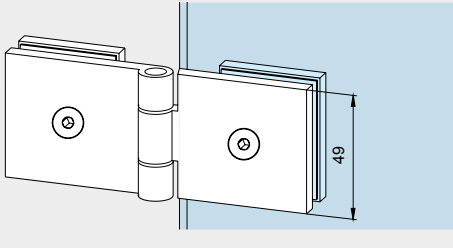
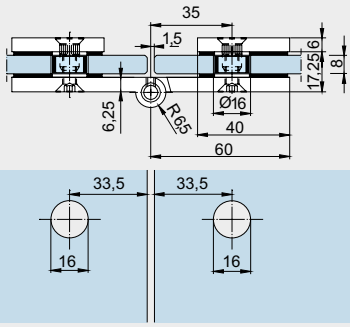
	Product description	Art.-Nr.
	Screw-on hinge without covers 49 mm, stainless steel pin, plastic bushing, door weight max. 30 kg Weight in kg: Aluminum 0.130	12.010
	Screw-on hinge with 3 covers 49 mm, stainless steel pin, plastic bushing, door weight max. 30 kg Weight in kg: Aluminum 0.152	12.011 (not illustr.)
	Screw-on hinge with cover for clamping plate, 86 mm, stainless steel pin, plastic bushing, door weight max. 45 kg Weight in kg: Aluminum 0.215	12.012
	Double hinge without covers 49 mm, stainless steel pin, plastic bushing, door weight max. 30 kg Weight in kg: Aluminum 0.208	12.030
	Double hinge with 4 covers 49 mm, stainless steel pin, plastic bushing, door weight max. 30 kg Weight in kg: Aluminum 0.243	12.031 (not illustr.)

Product description**Art.-Nr.****Double hinge with covers****12.032**

for clamping plates, 86 mm, stainless steel pin,
plastic bushing, door weight max. 45 kg

Weight in kg:

Aluminum 0.344

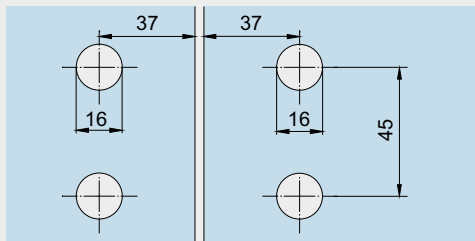
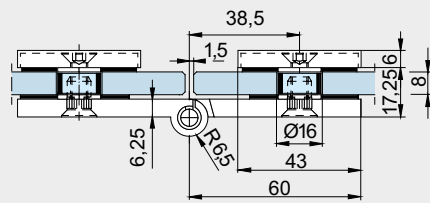
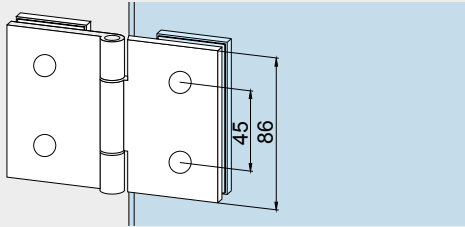

Corner hinges for 8 mm and 10 mm glass thickness

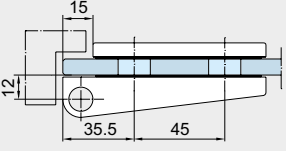
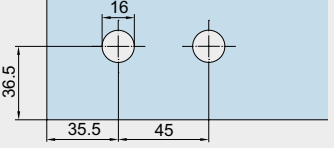
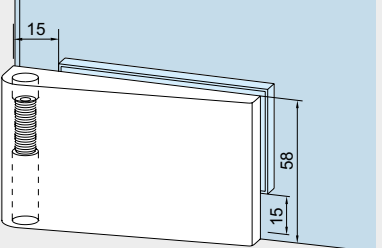
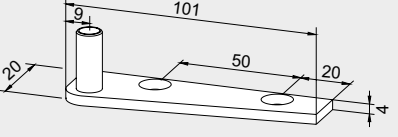
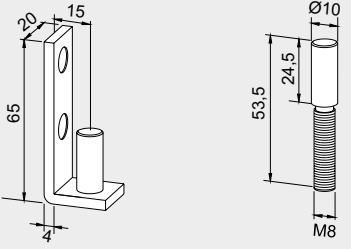
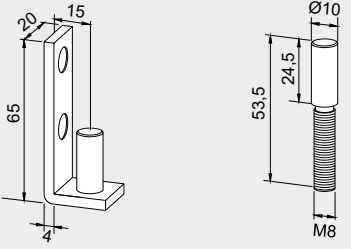
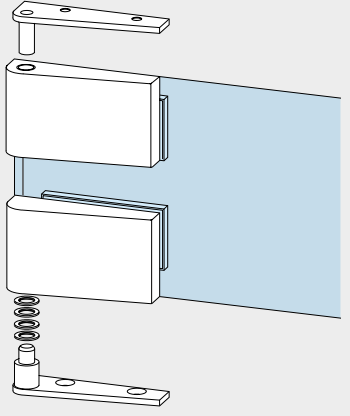
	Product description	Glass thickness	Art. No.
	<p>Corner hinges, pairs with free glass edge on top resp. underneath and at side, height adjustable, extended colour options, door weight max. 35 kg</p>	<p>8 mm 10 mm</p>	<p>12.001 12.009</p>
	<p>Weight in kg: Aluminum 0.130 Brass 1.006</p>		
	<p>Pair of floor and top pivot for corner hinges, brass satin chromed, stainless steel pin</p> <p>Weight in kg: 0.182</p>		12.016*
	<p>Piece of floor socket / top pivot left bottom / top right</p> <p>Weight in kg: 0.091</p>		12.014*
	<p>Piece of floor socket / top pivot right bottom / top left</p> <p>Weight in kg: 0.091</p> <p>Frame fixed pivot for corner hinges 12.001 and 12.009, brass satin chromed, stainless steel pin</p> <p>Weight in kg: stainless steel 0.132</p>		12.015*
	<p>Screw-in pivot stainless steel</p> <p>Weight in kg: stainless steel 0.048</p>		12.003*
	<p>Set of corner hinges for 8 and 10 mm glass thickness with free glass edge on top resp. underneath and at side (glass preparation like Art. No. 12.001)</p> <p>Consisting of 1 floor pivot, 1 bottom corner hinge (height adjustable), 1 top pivot, 1 top corner hinge, door weight max. 80 kg door width max. 1,100 mm</p> <p>Weight in kg: Aluminum 0.825</p>		<p>12.040 L 12.041 R (not illustr.)</p>

* Cannot be combined with corner hinges 12.040/12.041.

Content

Accessories

102	Frame pivots for internal glass doors
104	Frame pocket
104	push-on sleeves
107	Door rails for internal doors
109	Door bolts / door catch
112	Accessories door closer
169	Safety-related information

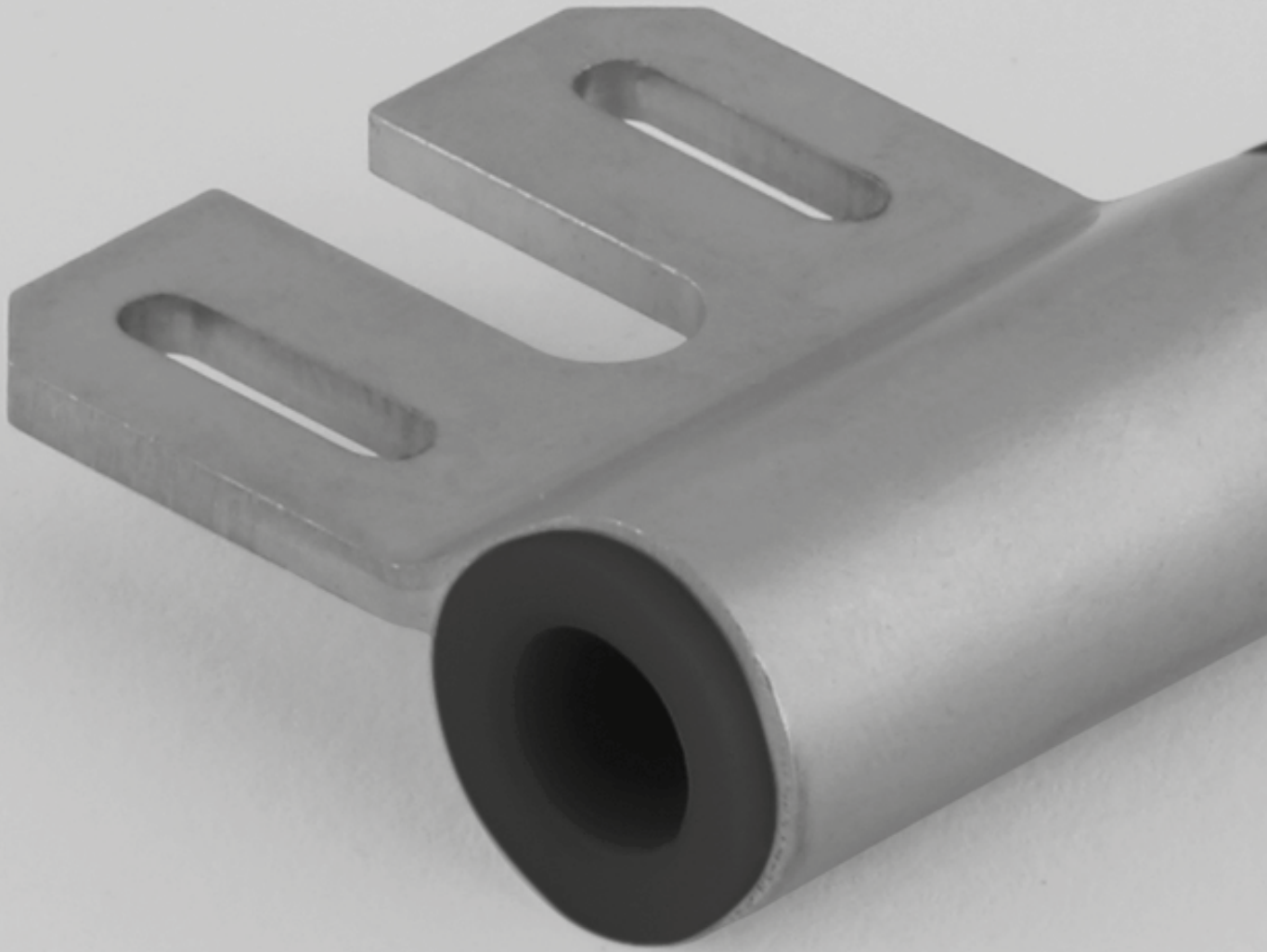

Accessories

Frame pivots for STUDIO

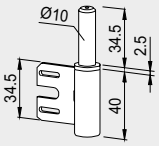
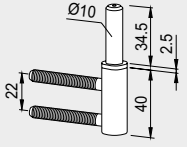
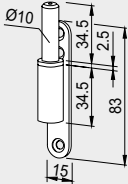
	Product description	Art. No.
	<p>Frame pivot for steel frames with extra enhanced pivot pin for STUDIO hinges, zinc plated steel, plastic coated pivot pin</p> <p>Weight in kg: 0.078</p>	10.423
	<p>Frame pivot for wooden frames with extra enhanced pivot pin for STUDIO hinges, zinc plated steel, plastic coated pivot pin</p> <p>Weight in kg: 0.090</p>	10.424
	<p>Screw-on frame pivot with extra enhanced pivot pin for Studio hinges, zinc plated steel, plastic coated pivot pin</p> <p>Weight in kg: 0.094</p>	10.407

Please note the rebate depth when choosing each door hinge.

Frame pivots for OFFICE

	Product description	Art. No.
	Frame pivot for 160 frame pocket (reception element for example VN 7608/160 3D, or equivalent) Satin stainless steel for door hinge 11.230, 11.288, 25.230, Weight in kg: 0.056	11.249
	Frame pivot for 120 mm type VN-frame pocket (reception element for example VN 7608/120 3D, or equivalent) stainless steel Weight in kg: 0.071	11.308
	Frame pivot for VX-frame pocket (reception element for example VX 7501 3D, or equivalent) stainless steel, plastic bushing, for all VX-mating portions, Weight in kg: 0.060	11.304
	Frame pivot for steel frames (reception element for example VN 8600, or equivalent) zinc plated steel, plastic bushing Weight in kg: 0.040	11.309
	Frame pivot for steel frames stainless steel, plastic bushing Weight in kg: 0.045	11.307
	Screw-on frame pivot zinc plated steel, plastic bushing, Weight in kg: 0.047 Please note: not usable with Art. No. 11.230 with finish satin stainless steel (Niro S 700 ST) (700)	11.405
	Frame pivot for wooden frames (reception element for example V 4400, or equivalent) zinc plated steel, plastic bushing Weight in kg: 0.055	11.310

Please note: the rebate depth when choosing each door hinge.

Frame pocket

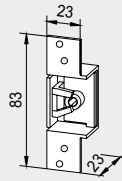
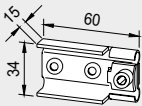
	Product description	Art. No.
	<p>Frame pocket for steel frame zinc plated steel</p> <p>Weight in kg: 0.073</p>	10.406
	<p>Frame pocket for wooden frame zinc plated steel</p> <p>Weight in kg: 0.060</p>	10.405

Push on sleeves

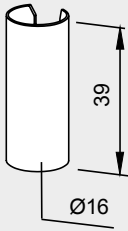
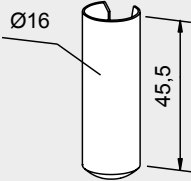
	Product description	Art. No.
	<p>Push-on sleeve for OFFICE frame pivots</p> <p>Art. No. 11.307 11.309 11.310 11.405</p> <p>Weight in kg: Aluminum 0.002</p>	11.311
	<p>Push-on sleeve for STUDIO frame pivots</p> <p>Art. No. 10.400 10.404 10.407</p> <p>Weight in kg: Aluminum 0.002 MS 0.006</p>	10.408

Strike plates

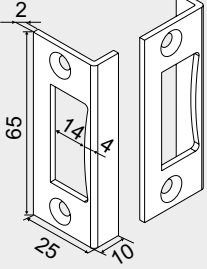
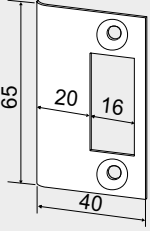
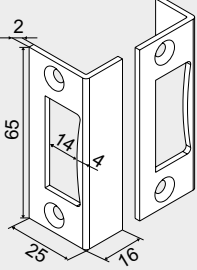
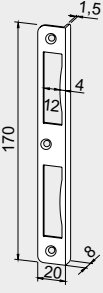
	Product description	Art.-Nr.
	<p>Corner strike plate</p> <p>Weight in kg: Aluminum 0.008</p>	<p>10.401</p>
	<p>Corner strike plate</p> <p>Weight in kg: Stainless steel 0.019</p> <p>Strike plate</p> <p>Weight in kg: Brass 0.022</p>	<p>10.421</p> <p>10.422</p>
	<p>Corner strike plate with 16 mm leg</p> <p>Weight in kg: Aluminum 0.008</p>	<p>10.411</p>
	<p>Corner strike plate</p> <p>Weight in kg: Aluminum 0.038</p>	<p>11.313</p>

Special latch for adaptation by the customer

	Product description	Art. No.
	Single latch for Austrian norm frames and for the combination of 10 mm glass with a 24 mm frame depth, usable for STUDIO Rondo, Classic, Gala and Arcos	10.066

Easy-Stop

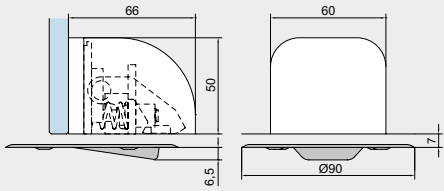
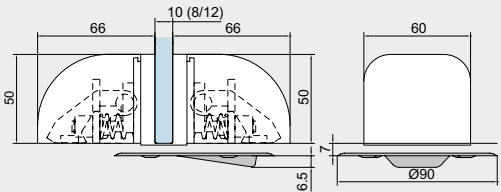
	Product description	Glass thickness	Art. No.
	Barrier-free floor doorstop for single-action doors, stainless steel adapter for bonding, plastic cover, with UV-adhesive Weight in kg: 0.335		10.591
	Barrier free floor doorstop – Easy Stop for double-action doors Stainless steel adapter for bonding, plastic cover Weight in kg: 0.679	8 mm 10 mm 12 mm	10.592 10.593 10.594
	Barrier free floor doorstop – Easy Stop for wooden and metal frame doors Weight in kg: 0.335		10.595 (not illustr.)

Further floor and wall door stops see page 111

Door rails for 8 mm and 10 mm glass thickness

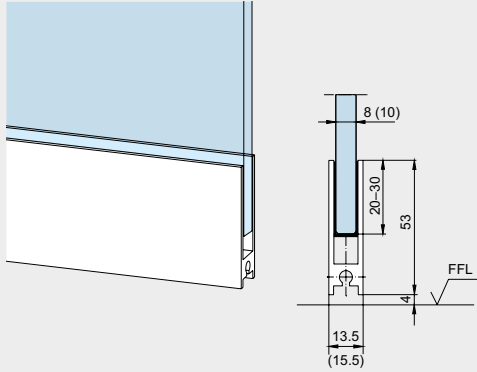
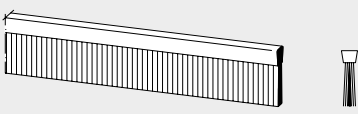

	Product description	Glass thickness	Art. No.
	Door rail push on fit, with pair of plastic end caps		
	norm length 834 mm	8 mm 10 mm	12.102 12.122
	norm length 959 mm	8 mm 10 mm	12.103 12.123
	stock length 1,200 mm	8 mm 10 mm	12.104 12.124
	fixed length 1,200 mm (for adaptation by the customer)	8 mm 10 mm	12.100 12.120
	Weight in kg: Aluminum 0.833		
	Brush seal to insert into door rails, with plastic brush, 5 mm projection, stock length 2,000 mm fixed length 1,200 mm stock length 1,000 mm fixed length 1,000 mm		12.110 12.111 12.115 12.116
	Weight in kg: 0.142	8 mm	12.106 (not illustr.)
	Plastic end cap black	8 mm	12.108 (not illustr.)
	Plastic end cap white	10 mm	12.108 (not illustr.)
	Weight in kg: 0,001		
	Plastic end cap black		
	Weight in kg: 0.001		
	Plastic end cap white	10 mm	12.109 (not illustr.)
	Weight in kg: 0.001		

Door rails with automatic seals

	Product description	Lengths	Surface	Glass thickness	Art. No.	
	Door rail with drop-down seal Schall-Ex® GS-A	833 mm	F 150 F 157	≥ 6 mm ≥ 6 mm	812.434.150.99 812.434.157.99	
	<ul style="list-style-type: none"> Seal and cover profile self-adhesive 	958 mm	F 150 F 157	≥ 6 mm ≥ 6 mm	812.439.150.99 812.439.157.99	
		<ul style="list-style-type: none"> Suitable for all doors with a glass thickness of 6 mm or more 	1083 mm	F 150 F 157	≥ 6 mm ≥ 6 mm	812.444.150.99 812.444.157.99
	<ul style="list-style-type: none"> Can be shortened 125 mm Retrofittable Stroke 11 mm 		1208 mm	F 150 F 157	≥ 6 mm ≥ 6 mm	812.449.150.99 812.449.157.99
			Transfer door rail with drop-down seal for bonding on site Schall-Ex® GS-H8/12	833 mm	F 150 F 157	8-12 mm 8-12 mm
	<ul style="list-style-type: none"> Universal glass door seal for doors with glass thicknesses from 8 - 12 mm 		958 mm	F 150 F 157	8-12 mm 8-12 mm	812.435.150.99 812.435.157.99
<ul style="list-style-type: none"> Unilateral triggering Stainless steel cover on lock side Can be shortened 125 mm Stroke 11 mm 			1083 mm	F 150 F 157	8-12 mm 8-12 mm	812.440.150.99 812.440.157.99
	1208 mm		F 150 F 157	8-12 mm 8-12 mm	812.445.150.99 812.445.157.99	
	Door rail with automatic seal, push on fit		834 mm	Left hand Right hand	8 mm 8 mm	12.202 12.203
	Weight in kg: Aluminum 1.559		959 mm	Left hand	10 mm	12.212
		Right hand		10 mm	12.213	
		959 mm	Left hand	8 mm	12.204	
			Right hand	8 mm	12.205	
		Fixed length up to 1,200mm	Left hand	10 mm	12.214	
			Right hand	10 mm	12.215	
		Fixed length up to 1,200mm	Left hand	8 mm	12.200	
			Right hand	8 mm	12.201	
		Fixed length up to 1,200mm	Left hand	10 mm	12.210	
			Right hand	10 mm	12.211	

All Planet door rails may be shortened by max. 125 mm on site. Please indicate the exact glass dimension with your order!

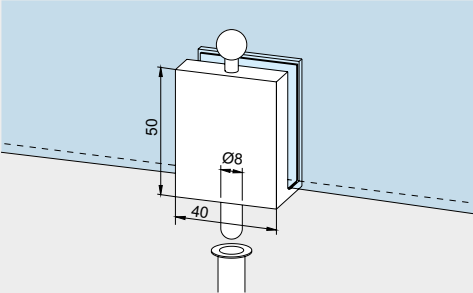
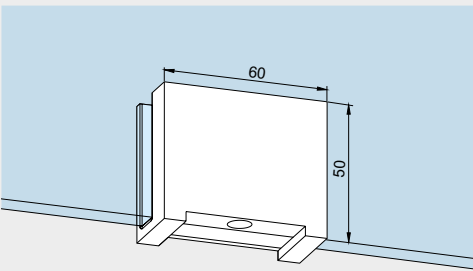
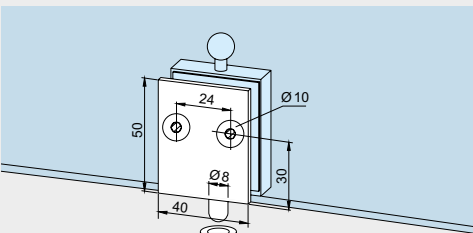
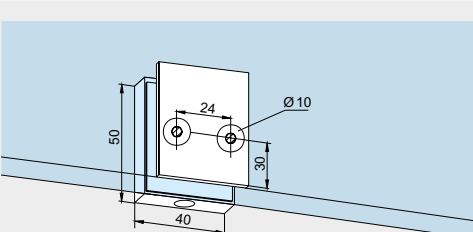
Door bolts

	Product description	Glass thickness	Art. No.
	Slide over door bolt with floor socket	8 mm	12.301
	Weight in kg: Aluminum 0.121		
	Slide over door bolt to slide over door bolt Art. No. 12.301	10 mm	12.302
	Weight in kg: Aluminum 0.113		
	Slide over strike box to slide over door bolt Art. No. 12.302	8 mm	12.314
	Weight in kg: Aluminum 0.160		
	Slide over strike box to slide over door bolt Art. No. 12.301	10 mm	12.317
	Weight in kg: Aluminum 0.130		
	Door bolt on glass preparation,	8 mm	12.312
	Weight in kg: Aluminum 0.121	10 mm	12.315
	Door bolt on glass preparation, with free glass edge	8 + 10 mm	12.318
	Weight in kg: Aluminum 0.099		
	Strike box on glass preparation	8 mm	12.313
	to door bolt Art. No. 12.312		
	Strike box on glass preparation	10 mm	12.316
	to door bolt Art. No. 12.315		
	Strike box on glass preparation		
	Weight in kg: Aluminum 0.087		

Door bolts

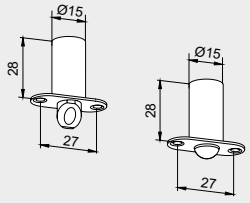
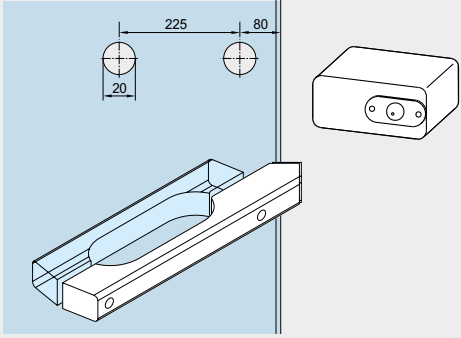
	Product description	Glass thickness	Art. No.
	Door catch plastic Weight in kg: plastic 0.007		12.300
	Door catch with round bolt Weight in kg: plastic 0.007		12.305
	Wooden snapper block for sauna , alder wood Weight in kg: wood 0.045		13.006
	Wooden handle for sauna , alder wood Weight in kg: wood 0.267		13.005

Profile cylinder

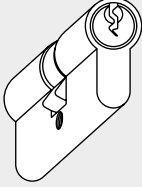
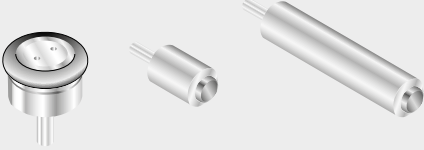
	Product description	Art. No.
	Profile cylinder length 61 mm, differently keyed, with dormakaba Logo	05.001
	Profile cylinder length 61 mm, equally keyed, with dormakaba Logo	05.002
	Further cylinders of the dormakaba range on demand.	
	Floor doorstop	29.950
	Wall doorstop short	29.951
	Wall doorstop long	29.952

TS 97

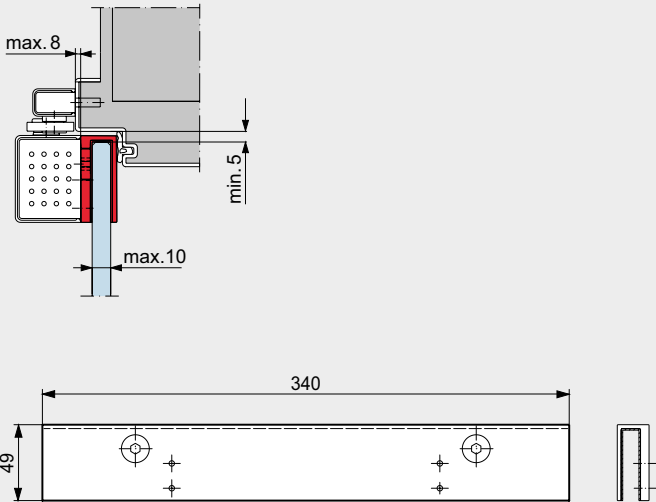
	Product description	Art. No.
	TS 97 inclusive glass fixing bracket No glass recess machining or drilling required. The TS 97 with this special glass fixing bracket should be used with STUDIO and OFFICE hinges.	18.070
For more information please see technical brochure TS 97.		

Accessories

for dormakaba Door Closer TS 73 V

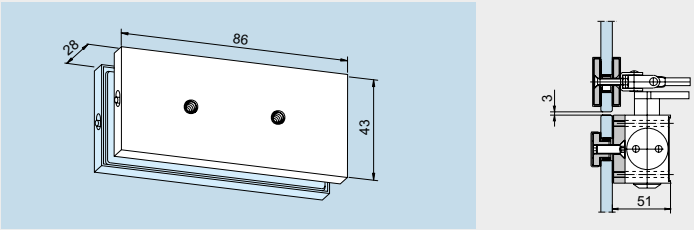
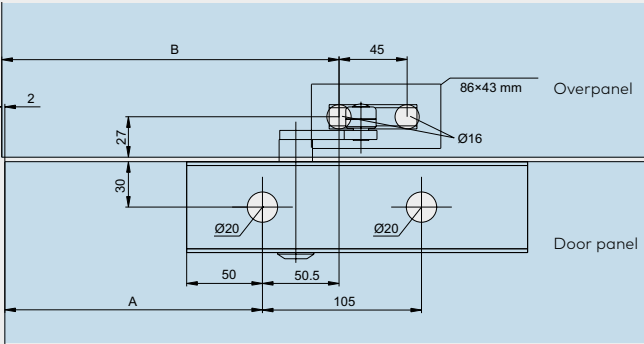
	Product description	Art. No.	
	Fixing plate for TS 73 V, projecting arm for overpanel	12.330	
	Weight in kg: Aluminum 0.132		
	Pivot point fitting	A	B
	EA (AT)	195	248
	UNIVERSAL / MUNDUS	245	298
	STUDIO / OFFICE	170	223
	UNIVERSAL Arcos	262	315

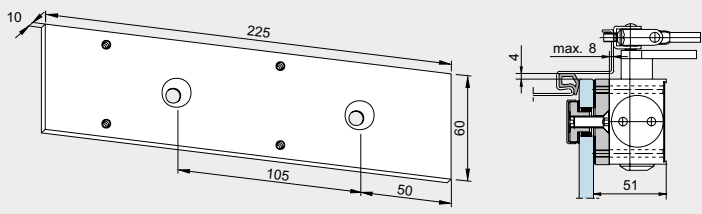
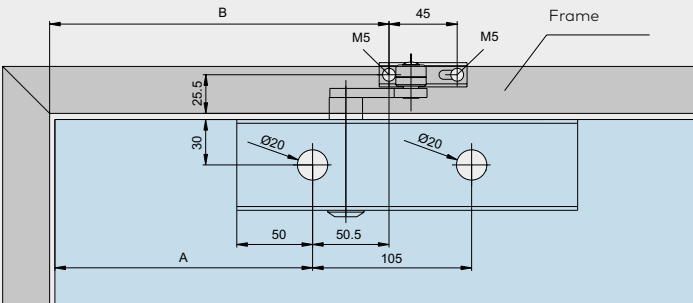
	Product description	Art. No.	
	Fixing plate 225 mm, for TS 73 V	12.335	
	Weight in kg: Aluminum 0.289		
	Pivot point fitting	A	
	EA (AT)	195	
	UNIVERSAL / MUNDUS	245	
	STUDIO / OFFICE	170	
	UNIVERSAL Arcos	262	

The door closers can only be purchased either through wholesale channels or directly from our Door Hardware division.

for dormakaba Door Closer TS 92

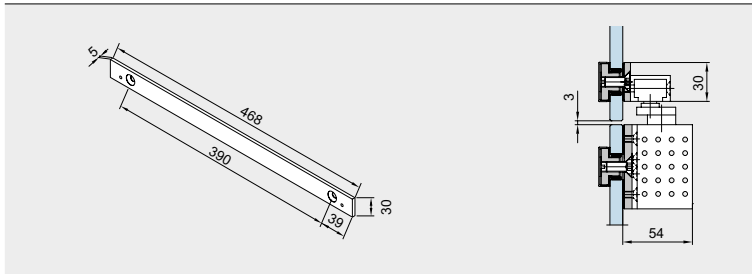

Product description

Art. No.

Fixing plate
for TS 92,
sliding rail for
overpanel. Further infor-
mation and installation
types you will find in the
technical brochure TS 92.

12.332

Weight in kg:
Aluminum 0.265

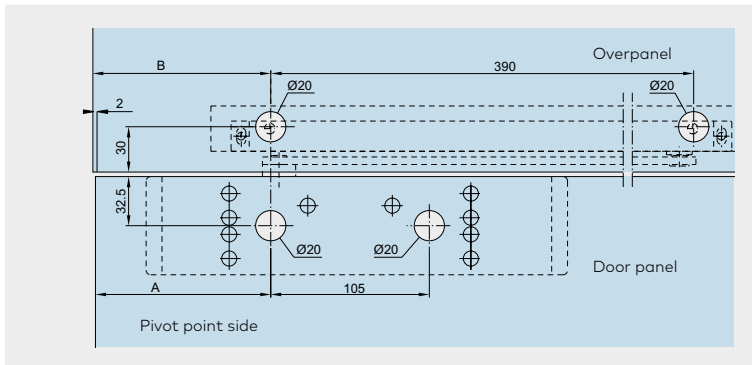

Pivot point fitting

A B

EA (AT)	200	202
UNIVERSAL / MUNDUS	250	252
STUDIO / OFFICE	148	150
UNIVERSAL Arcos	265	267

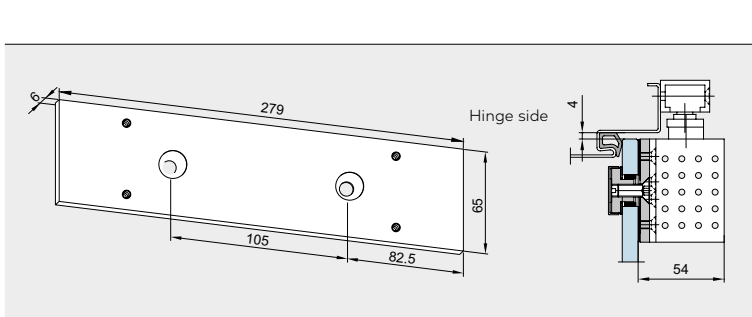

Product description

Art. No.

Fixing plate
279 mm,
for TS 92
(Issue 07/02)

12.334

Weight in kg:
Aluminum 0.290

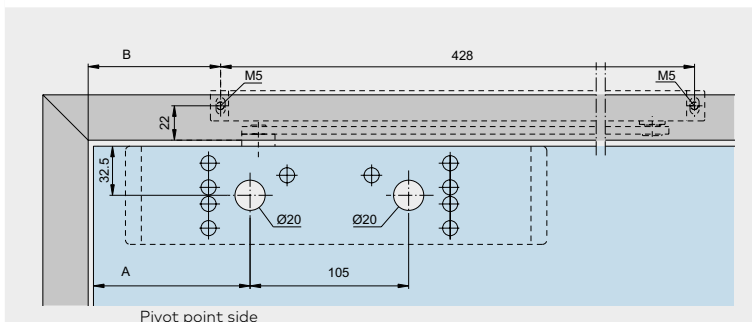

Pivot point fitting

A

EA (AT)	200
UNIVERSAL / MUNDUS	250
STUDIO / OFFICE	148
UNIVERSAL Arcos	265

Product description

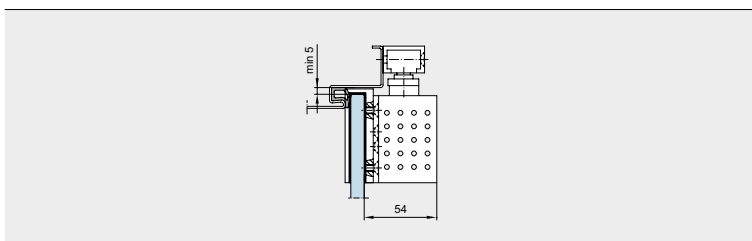

Saddle plate

Availabe for purchase
from our Door Hardware
division.

The door closers can only be purchased either through wholesale channels or directly from our Door Hardware division.

Content

Lever range



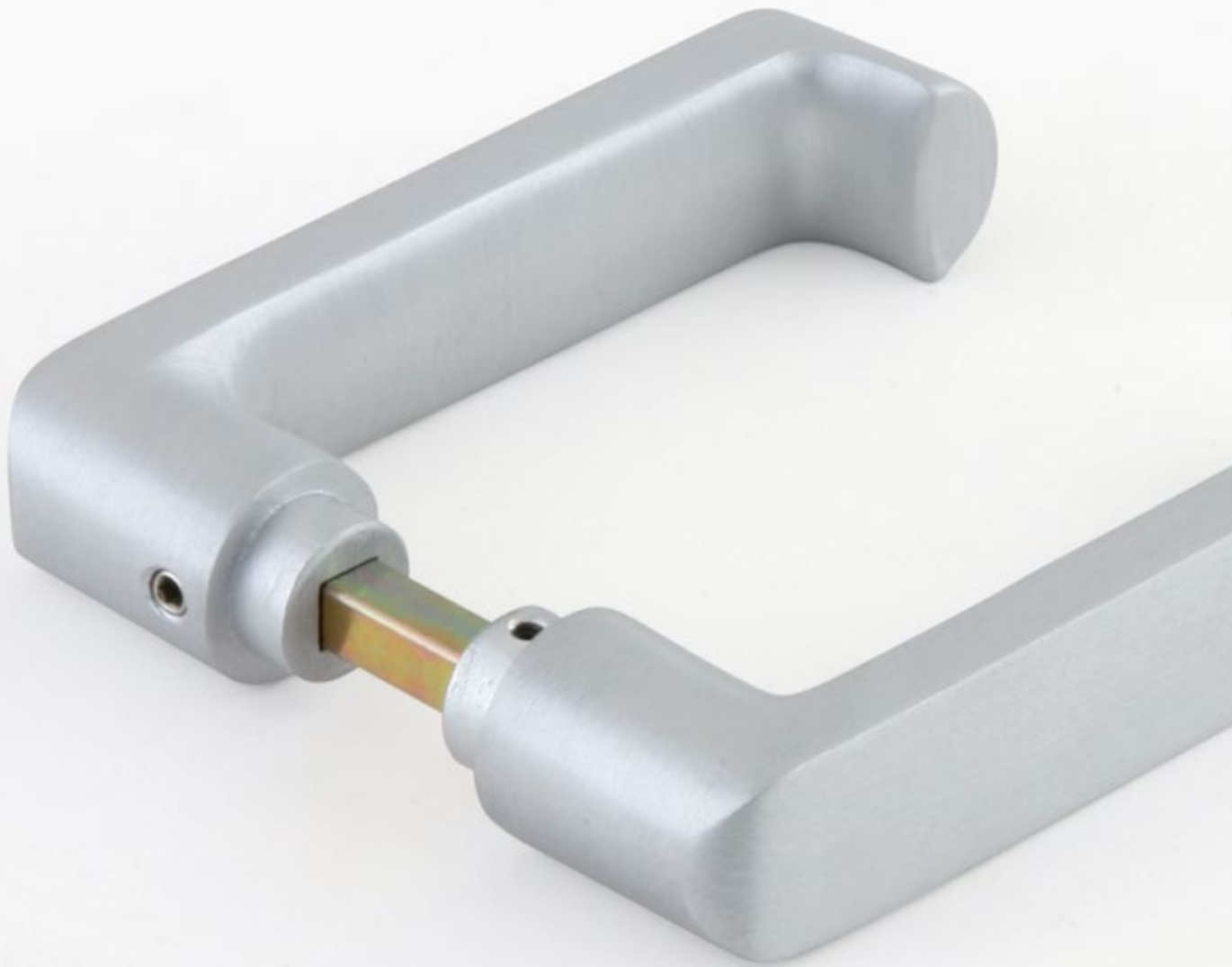

- 116 **Lever for follower**
- 119 **Levers with roses**
- 169 **Safety-related information**

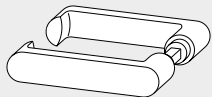
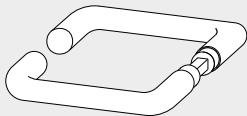
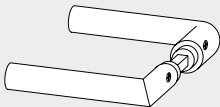
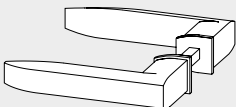
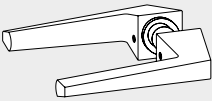
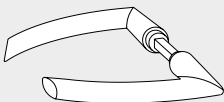

Lever range

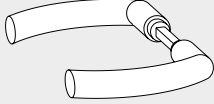
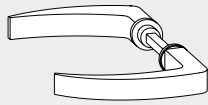
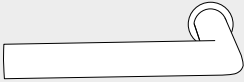
Sets of levers for locks with follower (diameter 18 mm)

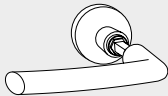
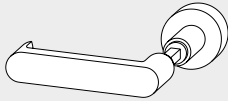

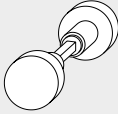
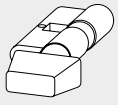

	Product description	Art. No.
	<p>Set of levers with flat hand part, extended colour options</p> <p>Weight in kg: Aluminum 0.290</p>	10.314
	<p>Set of levers tubular</p> <p>Weight in kg: Aluminum 0.320</p>	10.301
	<p>Set of levers tubular, for follower, with stainless steel square drive</p> <p>Weight in kg: Aluminum 0.452</p>	10.322
	<p>Set of levers OFFICE levers</p> <p>Weight in kg: Stainless steel 0.381</p>	11.299
	<p>Set of levers</p> <p>Weight in kg: Aluminum 0.350</p>	19.009
	<p>Set of levers with angular hand part</p> <p>Weight in kg: Aluminum 0.392</p>	10.010
	<p>Arcos Set of levers</p> <p>Weight in kg: Aluminum 0.353 Brass 0.959</p>	24.301

	Product description	Art. No.
	<p>Set of levers with oval handle</p> <p>Weight in kg: Aluminum 0.300</p>	24.310
	<p>Set of levers with angular handle</p> <p>Weight in kg: Aluminum 0.267</p>	24.312
	<p>Lever MAME 33</p> <p>Weight in kg: stainless steel 0,380</p>	52.330
	<p>Lever MAME 01</p> <p>Weight in kg: stainless steel 0,380</p>	52.010
	<p>Arcos lever and knob set with Arcos lever and free turnable knob (turnable knob without function)</p> <p>Weight in kg: Aluminum 0.335</p>	24.316
	<p>Lever and knob set lever with flat hand part, fixed knob, for use with nightlatch function locks (turnable knob without function)</p> <p>Weight in kg: Aluminum 0.270</p>	10.304
	<p>Lever and knob set tubular lever with free turning knob (turning without function)</p> <p>Weight in kg: Aluminum 0.335</p>	10.316
	<p>Lever and knob set tubular lever with turning knob</p> <p>Weight in kg: Aluminum 0.345</p>	10.317

Sets of levers for locks with follower

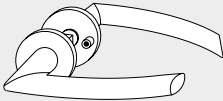
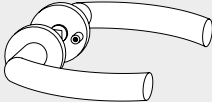
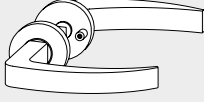
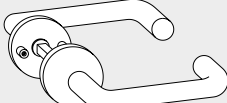
	Product description	Art. No.
	<p>Set of knobs turning knob</p> <p>Weight in kg: Aluminum 0.255</p>	<p>10.305</p>
	<p>Thumbturn cylinders (WC), for locks prepared for Europrofile cylinder, thumbturn in aluminum, extended colour options</p> <p>Weight in kg: 0.225</p>	<p>10.310</p>

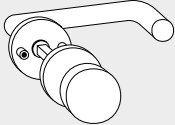
Sets of levers for locks prepared for levers with roses

	Product description	Art. No.
	Arcos Set of levers with roses Weight in kg: Aluminum 0.420	24.307
	Set of levers with oval handle, with roses Weight in kg: Aluminum 0.379	24.311
	Set of levers with angular handle, with roses Weight in kg: Aluminum 0.344	24.313
	Set of levers tubular, with roses Weight in kg: Aluminum 0.320	10.307
	Arcos lever and knob set with Arcos lever and free turnable knob (turnable knob without function) Weight in kg: Aluminum 0.377	24.318
	Lever and knob set tubular lever with fixed knob, with roses Weight in kg: Aluminum 0.400	10.318
	Lever and knob set tubular lever with knob, with roses Weight in kg: Aluminum 0.400	10.319

Sets of levers with roses for wooden doors

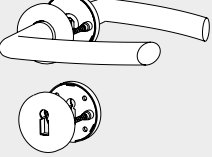
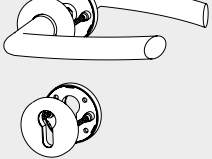
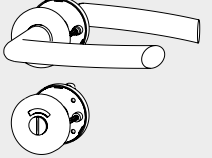
	Product description	Art. No.
	<p>Set of levers for wooden doors incl. warded key rose</p> <p>Weight in kg: Aluminum 0.485</p>	24.322
	<p>Set of levers for wooden doors incl. profile cylinder rose</p> <p>Weight in kg: Aluminum 0.485</p>	24.323
	<p>Set of levers for wooden doors incl. vacant / occupied indicator</p> <p>Weight in kg: Aluminum 0.531</p>	24.324

Space for your notes

Content

BEYOND

124	General information
127	Type illustrations / sets
130	Components
130	Glass preparation
156	Accessories
168	Finishes and colours
169	Safety-related information



BEYOND

Systematic design

Safe, functional and extremely attractive, BEYOND, the unique system for glass doors without risk of pinched fingers with swing doors.

The development of BEYOND has been shaped by the search for a solution that combines a modern, attractive design with maximum safety and stability. In the swing-door system the pivot point is located directly at the glass edge, thus preventing the risk of trapped fingers often found at the secondary closing edges of glass swing.

BEYOND opens up a huge range of opportunities for incorporating frameless glass doors into toughened glass assemblies and wall openings. The BEYOND system offers an elegant, sophisticated solution for swing doors in all situations, whether private or public, modern or traditional.

Developed with the practical requirements of the market in mind, this product offers a sensible alternative wherever security, safety and functionality need to be complemented with an attractive design.



Safe and secure

The patented BEYOND swing door system with its pivot point located centrally in the glass axis and close to the glass edge ensures safety and security. The alternative options of elegant, continuous pivot rod or smart short rod make the system suitable for any room situation. And with a choice of pull handles or lock/lever handle combinations, BEYOND enables the realisation of your design ideas.



The over panel pivot fitting
– a slim connector.



An option for the bottom pivot point – short rod on a floor pivot.

If floor pivot bearings are being used, a separate lock or a tumbler is required.

Short pivot rod

The BEYOND swing door system with short pivot rod offers maximum flexibility. No matter what the door dimensions, BEYOND short fittings provide a versatile solution.

dormakaba floor pivots, or – particularly for double-action doors – dormakaba BTS floor springs, form the ideal base for ensuring that the door always returns safely and securely to its home position. Since with the BTS floor spring the position of the pivot point requires it to be buried under the adjacent wall, the use of a glass side panel is recommended in this case. The top connection depends on the type of unit. When incorporating the glass door into a toughened glass assembly, the top connection is formed by an over panel fitting; in the case of doors in wall openings, a top pivot bearing is fitted to the ceiling or in the lintel. Load

transfer from the overpanel and side panel can be effected by means of wall adapter profiles.

Depending on customer requirements, BEYOND offers suitable fittings for 10 mm and 12 mm glass. Finishes for fittings and accessories: aluminum EV1-Deco anodized (114) or similar satin stainless steel anodized (107).

For maximum values please see the typical assemblies.

Note:

Overpanel fitting wall connector
 max. 1,200 mm door width;
 overpanel fitting glass connector
 max. 1,000 mm door width.

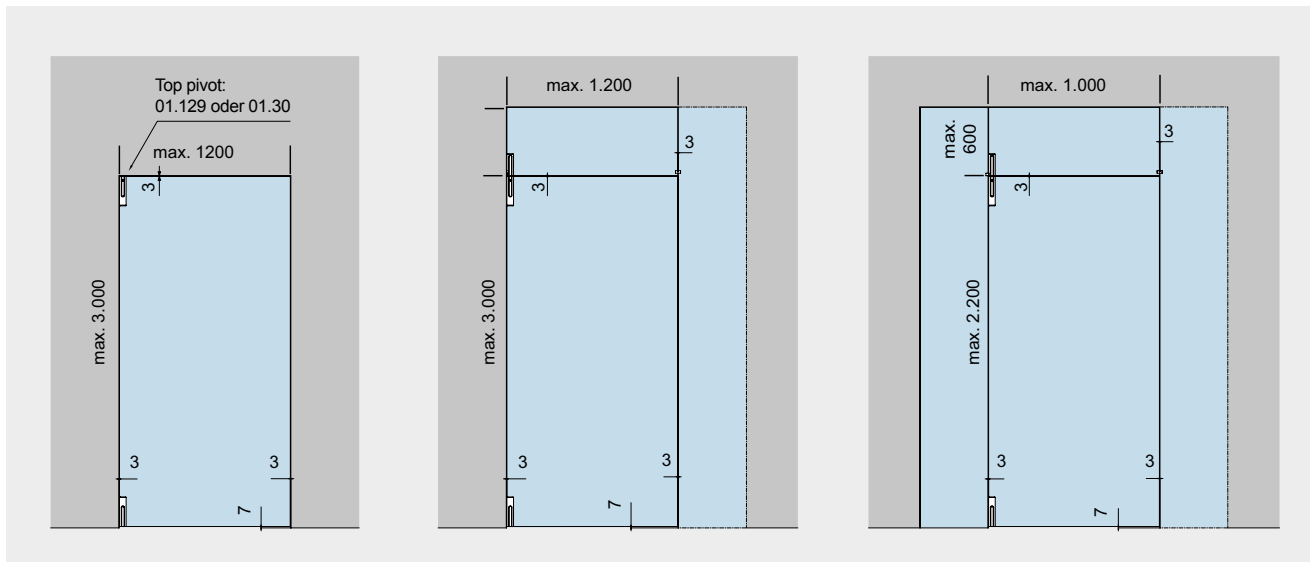

Basic set for individual door.
 For installation in masonry.

Max door height 3,000 mm
 Max door weight 80 kg

Basic set and over panel fitting wall connector for door with over panel.
 Optionally with side panel on closing side.

Max door height 3,000 mm
 Max door weight 80 kg

Basic set and over panel fitting wall connector for door with over panel and side panel on pivot point side.
 Optionally with side panel on closing side.

Max door height 2,200 mm
 Max door weight 80 kg

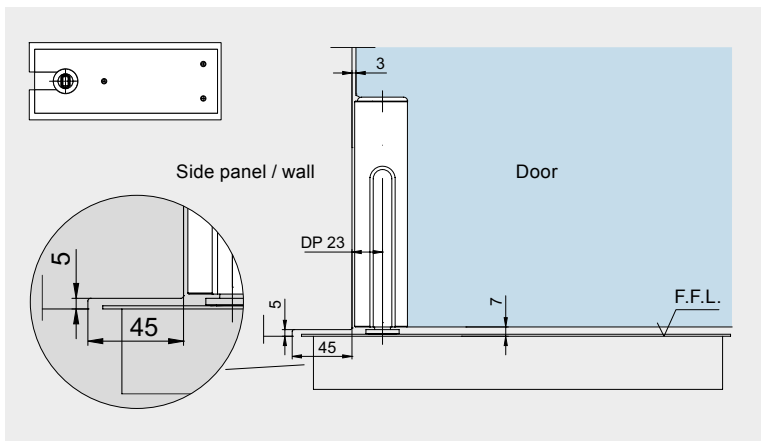

Combination BEYOND and BTS

(door closer available from Door Control Division)
 With the BTS floor spring, the position of the pivot point means that the unit has to be buried under the adjacent wall, or that the glass side screen has to be appropriately machined (see adjacent detail). The height of the recess cut into the glass will need to be adapted to the installation situation and the means by which the side screen is fixed.

Fittings and glass connector

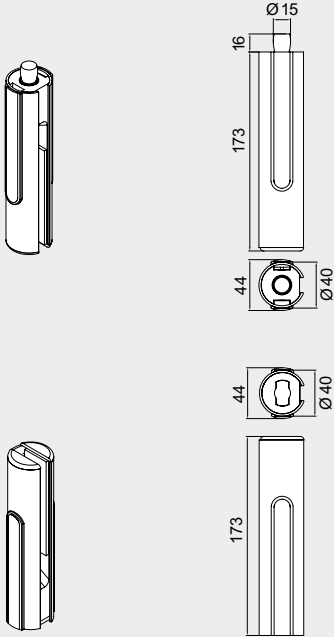
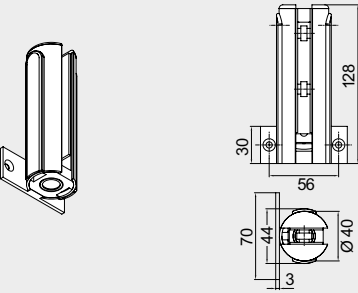
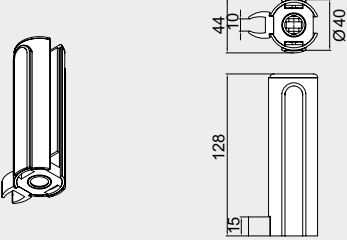
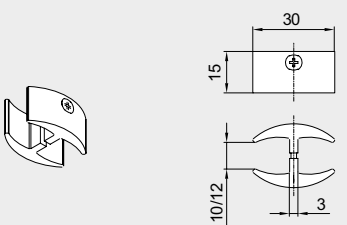
	Product description	Glass thickness	Art. No.
	<p>BEYOND basic set: Pivoting fitting set, short type, comprising</p> <ul style="list-style-type: none"> • 1 top pivot fitting with pivot Ø 15 mm, • 1 bottom pivot fitting with insert for floor spring spindle (90° turnable, e. g. dormakaba BTS 80) or round pivot 	10 mm 12 mm	30.100 30.101
	<p>BEYOND overpanel fitting, wall connector, with plastic socket for top pivot</p>	10 mm 12 mm	30.120 30.121
	<p>BEYOND overpanel fitting, glass connector, with plastic socket for top pivot</p>	10 mm 12 mm	30.130 30.131
	<p>BEYOND glass connector, plastic, black, for connection of side panel at closing side</p>	10 mm and 12 mm	30.320

Continuous pivot rod

The BEYOND swing door system with continuous rod offers complete freedom from the risk of trapped fingers. By locating the pivot point of the swing door right at the glass edge and providing a round profile, the nip hazard is reduced to zero.

For the floor mounting of single-action, and particularly double-action doors, the BTS floor spring offers a convenient alternative to the dormakaba floor pivot. Since with the BTS floor spring the position of the pivot point requires it to be buried under the adjacent wall, the use of a glass side panel is recommended in this case. As with the short-rod model, the top connection depends on the type of unit. Toughened glass assemblies are fitted with an over panel pivot fitting, whereas with doors in wall openings a top pivot bearing with ceiling fixing is used. Load transfer from the over panel and side panel can be effected by means of wall adapter profiles.

In the case of heights over 2,200 mm, an anti-vibration device located midway along the pivot rod ensures quiet door operation.

Depending on customer requirements, BEYOND offers suitable fittings for 10 mm and 12 mm glass.

Finishes for fittings and accessories: aluminum EV1-Deco anodized (compatible with finish 150) (114) or similar satin stainless steel anodized (107).

For maximum values please see the typical assemblies.

Note:

Overpanel fitting wall connector
max. 1,200 mm door width;
overpanel fitting glass connector
max. 1,000 mm door width.

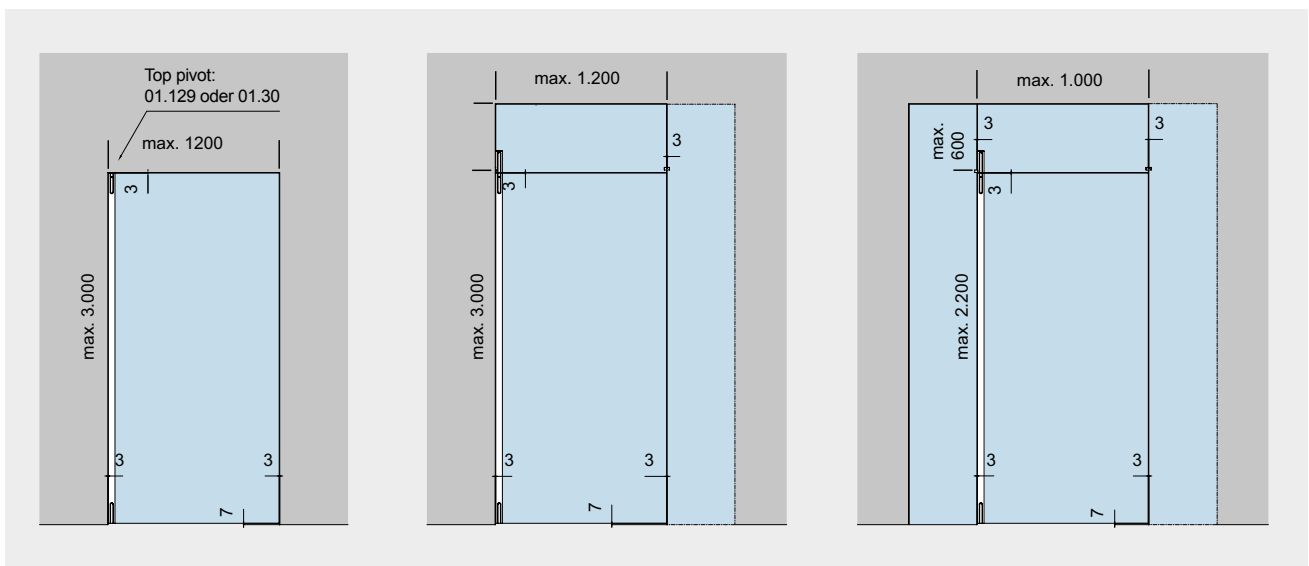

Basic fitting for individual door.
For installation in masonry.

Max door height 3,000 mm
Max. door weight 80 kg

Basic fitting and over panel fitting wall connector for door with over panel.
Optionally with side panel on closing side.

Max door height 3,000 mm
Max. door weight 80 kg

Basic fitting and over panel fitting wall connector for door with over panel and side panel on pivot point side.
Optionally with side panel on closing side.

Max door height 2,200 mm
Max. door weight 80 kg

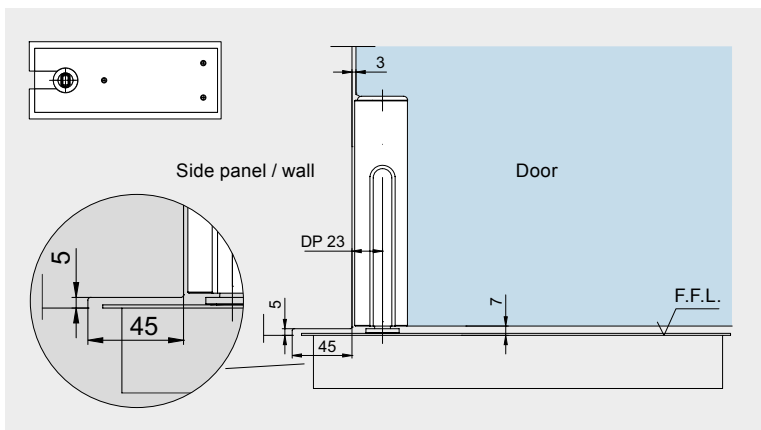

Combination BEYOND and BTS

(door closer available from Door Control Division)
With the BTS floor spring, the position of the pivot point means that the unit has to be buried under the adjacent wall, or that the glass side screen has to be appropriately machined (see adjacent detail). The height of the recess cut into the glass will need to be adapted to the installation situation and the means by which the side screen is fixed.

Fittings and glass connector

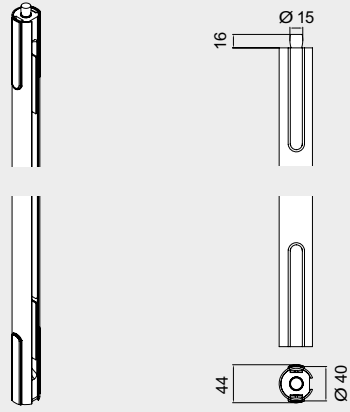
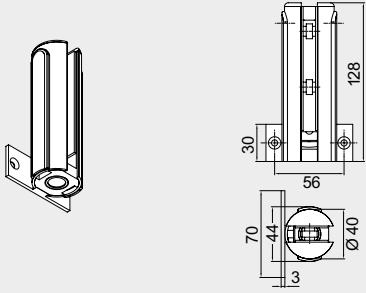
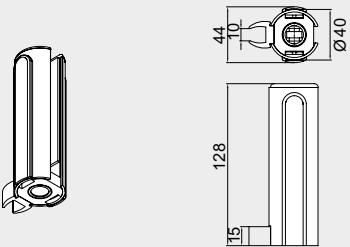
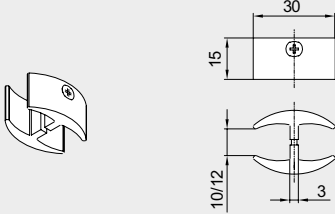
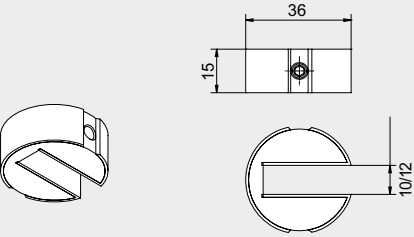
	Product description	Glass thickness	Art. No.
	<p>BEYOND basic fitting: Pivoting fitting, long type, with pivot \varnothing 15 mm at top and insert for floor spring spindle (90° turnable, e. g. BTS 80) or round pivot at bottom</p> <p>Please indicate exact door height = glass measurement with order.</p>	<p>10 mm 12 mm</p>	<p>30.110 30.111</p>
	<p>BEYOND overpanel fitting, wall connector, with plastic socket for top pivot</p>	<p>10 mm 12 mm</p>	<p>30.120 30.121</p>
	<p>BEYOND overpanel fitting, glass connector, with plastic socket for top pivot</p>	<p>10 mm 12 mm</p>	<p>30.130 30.131</p>
	<p>BEYOND glass connector, plastic, black, for connection of side panel at closing side</p>	<p>10 mm and 12 mm</p>	<p>30.320</p>
	<p>BEYOND anti-vibration device for pivot fitting, long</p>	<p>10 mm 12 mm</p>	<p>30.034 30.035</p>

Glass preparation

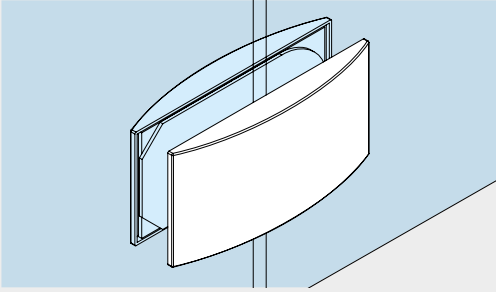
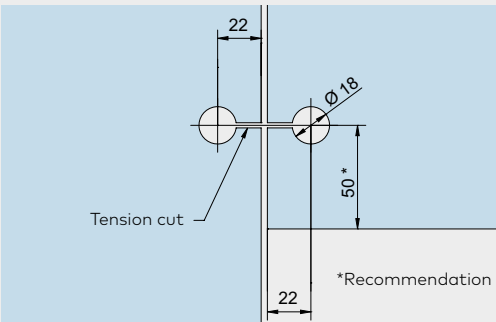
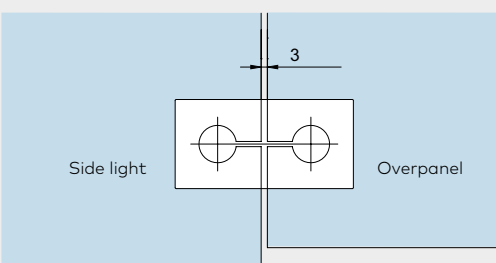
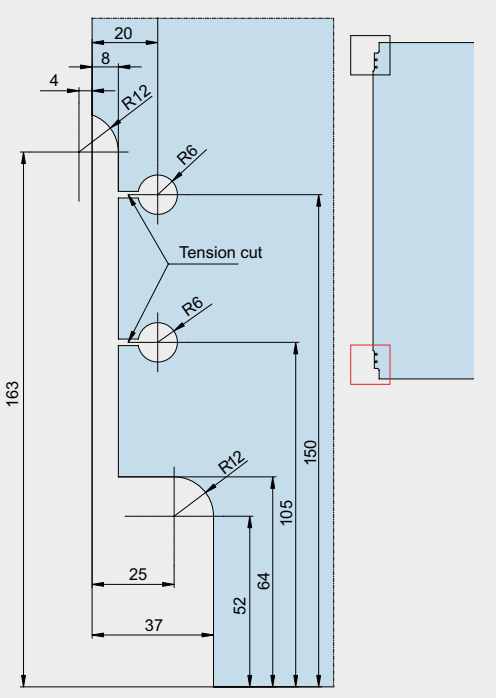
	Product description	Art. No.
	<p>Overpanel-sidelight connector</p> <p>Weight in kg: Aluminum 0.146</p>	<p>12.536</p>
		
		
	<p>Pivoting fitting set, short type</p> <p>Drawing shows the bottom glass penetration. Top edge of glass is prepared accordingly.</p>	<p>30.100 30.101</p>

Product description

Art. No.

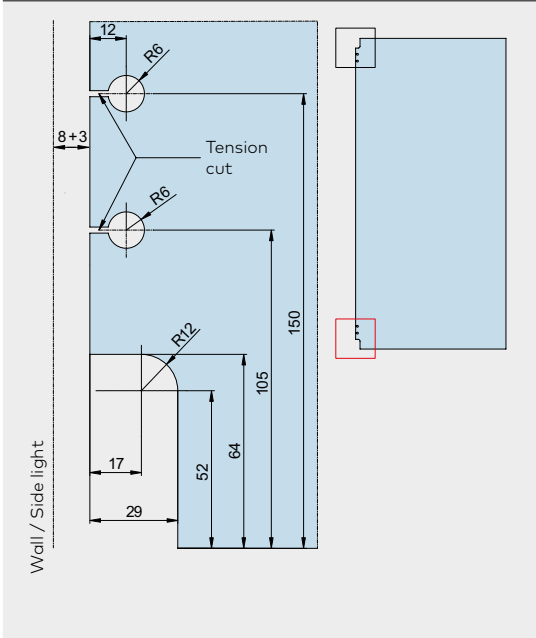

Pivoting fitting, long type

Drawing shows the bottom glass penetration.
Top edge of glass is prepared accordingly.

30.110

30.111

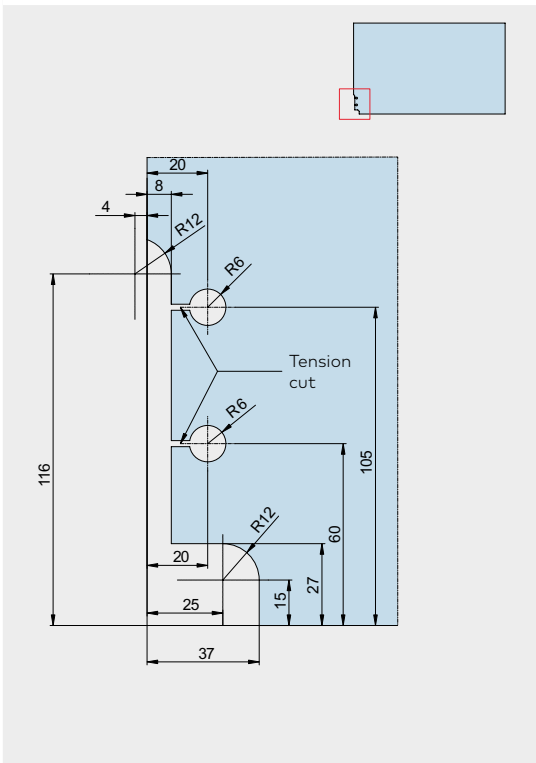

Overpanel fitting

Wall connector and
glass connector

30.120

30.121

30.130

30.131

Content

TENSOR

134	General information
136	Type illustrations
100, 156	Accessories
169	Safety-related information



TENSOR

Convenience – Precision – TENSOR

There are many arguments in favour of installing a toughened glass door – as many as there are applications and functional possibilities. Double-action doors offer particular convenience. And all the more so where the door is returned to the desired closed position by the action of the hinges alone – without any need for a recessed floor spring or an overhead door closer cluttering the top edge of the glass panel.

The TENSOR concept sets a new standard in this regard – whether for new installations or refurbishments.

TENSOR double-action door hinges can be fixed directly to the masonry or to a non-rebated frame. In the case of "glass-to-glass" model, the double-action door is hung from a fixed toughened glass side screen.

Excellent returns from every angle

Viewed "superficially", the TENSOR design exhibits a slightly convex, curved form. Also attractively conspicuous is the inlay of the dormakaba brand, harmoniously integrated within the satin-finished aluminum hinge components. The emblem may be selected to match or to contrast with the hinge finish – three inlays of different colours are provided with each set. The inlay serves as a mechanical stop for the hinge, thus protecting the surface of the fixed hinge section against damage when the door is opened to 90°.

And it also conceals to the technical core of the system – the simple and high-precision zero-position adjustment mechanism. This is an essential feature for ensuring the effective and efficient closing of a double-action door.

At 90°, the TENSOR system holds the door firmly and securely in position. Once pushed in the closing direction, the spring mechanism of the TENSOR fitting takes over, operating from an angle of 75°. The door closes quickly and securely. And even at an opening angle of 3°, the torque of 7 Nm created is sufficient to keep the door conveniently in its closed position.



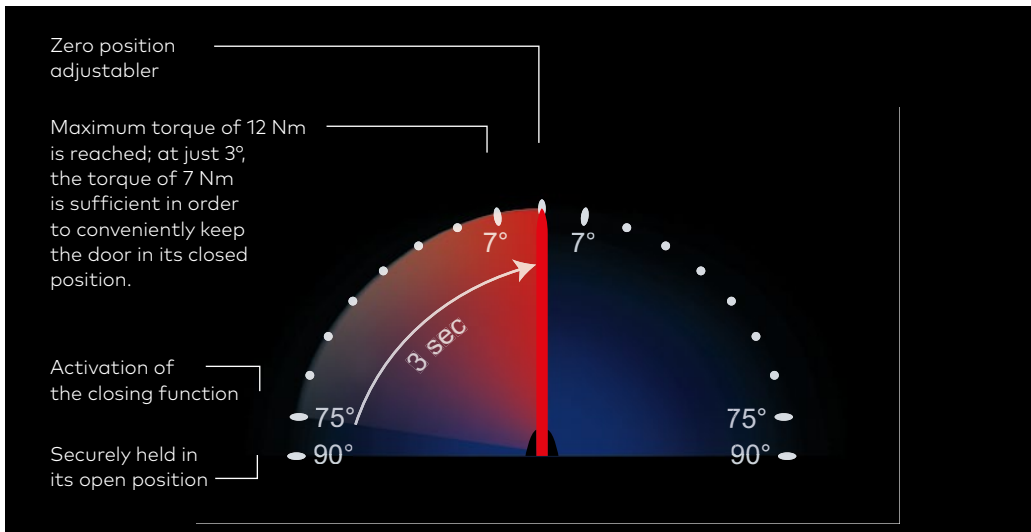

For wall / frame fixing

	Product description	Glass height	Glass width
	<p>TENSOR Double-action door fixed to wall / frame with surface mounted mounting plate</p> <p>Single leaf</p> <p>Fittings for 8, 10 and 12 mm glass Door weight: max. 65 kg Door width: max. 1,000 mm</p> <p>LH = Clear height LB = Clear width</p> <p>* for glass height 1,800 - 2,500 mm (min. 700 mm panel width)</p>	LH-10	LB-6
	<p>TENSOR Double-action door fixed to wall / frame with surface mounted mounting plate</p> <p>Double leaf</p> <p>Fittings for 8, 10 and 12 mm glass Door weight: max. 65 kg Door width: max. 1,000 mm</p> <p>LH = Clear height LB = Clear width</p> <p>* for glass height 1,800 - 2,500 mm (min. 700 mm panel width)</p>	LH-10	$(LB-10)/2$

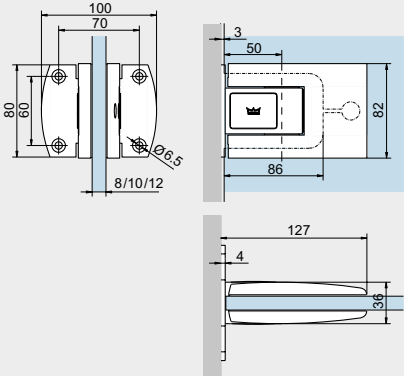
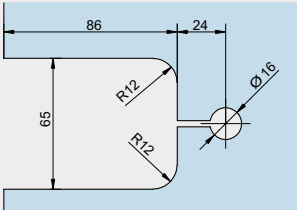
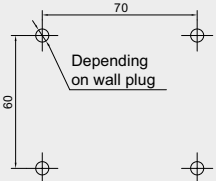
	Product description	Glass thickness	Art. No.
	<p>TENSOR Double-action hinges</p> <p>Pair of double-action hinges incl. mounting plate, round; for installation onto wall or frame with surface mounted mounting plate</p> <p>dto but with 2 stops (29.950)</p> <p>Finishes: AL EV1-Deco anodized (114) (compatible with finish 150) AL similar satin stainless steel anodized (113)</p>	<p>8, 10 and 12 mm</p>	<p>12.520</p> <p>12.527</p>
	<p>Glass preparation</p>		
	<p>Drilling scheme</p>		
	<p>Please note: Condition is a suitable substructure!</p> <p>For the frame installation our inside frame connector 12.526 is available (Detail: 12-152A).</p> <p>Excessive opening of the door must be prevented (max. 90°). Please use a door stop – see page 140</p>		

Glass to glass

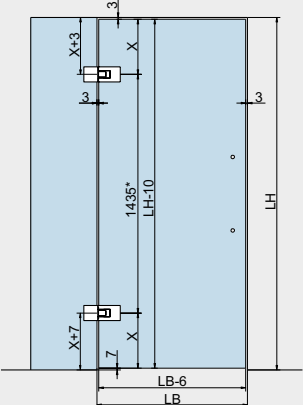
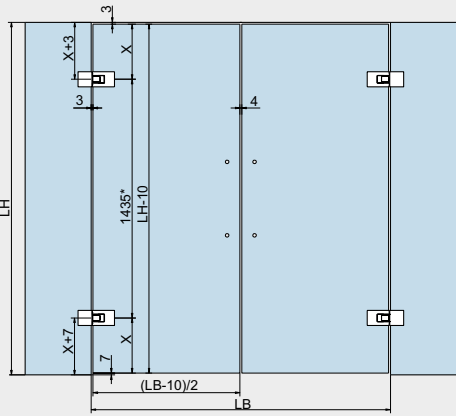
	Product description	Glass height	Glass width
	<p>TENSOR Double-action door fixed to glass side panel</p>	LH-10	LB-6
<p>Single leaf</p>			
<p>Fittings for 8, 10 and 12 mm glass Door weight: max. 65 kg Door width: max. 1,000 mm Side panel width: max. 1,500 mm</p>			
<p>LH = Clear height LB = Clear width</p>			
<p>* for glass height 1,800 - 2,500 mm (min. 700 mm panel width)</p>			
	<p>TENSOR Double-action door fixed to glass side panel</p>	LH-10	(LB-10)/2
<p>Double leaf</p>			
<p>Fittings for 8, 10 and 12 mm glass Door weight: max. 65 kg Door width: max. 1,000 mm Side panel width: max. 1,500 mm</p>			
<p>LH = Clear height LB = Clear width</p>			
<p>* for glass height 1,800 - 2,500 mm (min. 700 mm panel width)</p>			
<p>Note: The fixed parts must be installed all around the wall connection profile (see technology brochure Fittings for toughened glass systems).</p>			

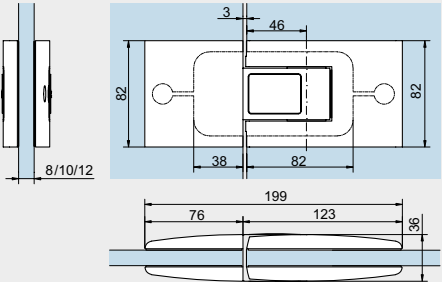
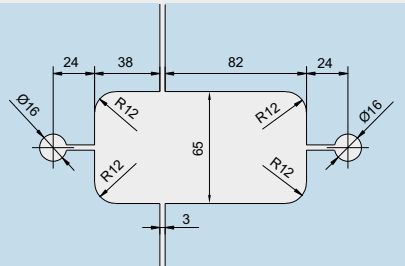
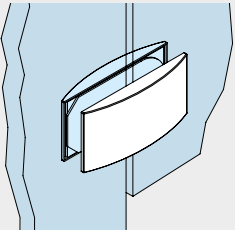
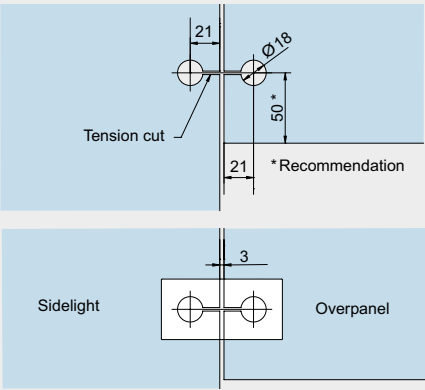
	Product description	Glass thickness	Art. No.
	<p>TENSOR Double-action hinges</p> <p>Pair of double-action hinges for installation glass to glasse</p> <p>dto but with 2 stops (29.950)</p> <p>Finishes: AL EV1-Deco anodized (114) (compatible with finish 150) AL similar satin stainless steel anodized (113)</p>	<p>8, 10 and 12 mm</p>	<p>12.523</p> <p>12.529</p>
	<p>Glass preparation / Drilling scheme</p> <p>for Art. No. 12.523</p>		
	<p>Overpanel-sidelight connector</p> <p>Weight in kg: Aluminum 0.146</p>		<p>12.536</p>
	<p>Glass preparation / Drilling scheme</p> <p>for Art. No. 12.536</p>		

Excessiv opening of the door must be prevented (max. 90°).
 Please use a door stop – see page 140

Accessories

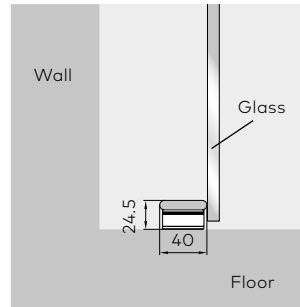
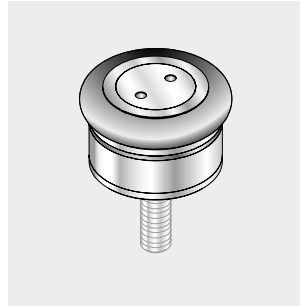
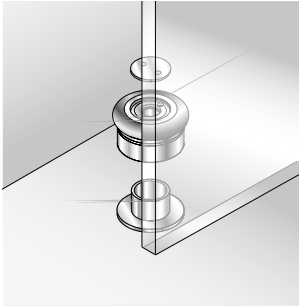

Ordering information

Stop for pivoting door
 floor mounting
Art. No. 29.950

Easy-Stop

	Product description	Glass thickness	Art. No.
	<p>Barrier free floor doorstop – Easy Stop for double-action doors Stainless steel adapter for bonding, UV-adhesives plastic cover</p>	<p>8 mm 10 mm 12 mm</p>	<p>10.592 10.593 10.594</p>
	<p>Barrier-free floor doorstop for single-action doors, stainless steel adapter for bonding, plastic cover</p>		<p>10.591</p>
<p>Weight in kg: Aluminum 0.679</p>	<p>Weight in kg: Aluminum 0.335</p>		

Space for your notes

Content

VISUR

144	General information
146	Type illustrations
147	Complete sets
149	Components
100	Accessories
169	Safety-related information



**The VISUR
product line
will be removed
from the program
in 2021**



VISUR

VISUR – purest clarity

All-glass double-action doors without any visible fixings? Meet VISUR, a system patented for dormakaba that secures double-action glass doors without the need for any visually disruptive functional elements. VISUR presents the door in perfect transparency. Rather than cluttering the clear outline of the leaf, the hardware components are all located in the surrounding structures.

This absence of fittings means that the all-glass double-action door will match any room style, making the VISUR system a real boon to interior architecture.

100% transparent 100% durable

Frameless from top to toe – that's the VISUR's claim to fame, making life easier for architects and specifiers alike.

Because they can choose any material and any colour for the surrounding structures. The VISUR system simply remains a discrete presence, fitting in with every design idea and reflecting it to maximum advantage.

Having successfully completed 500,000 operating cycles in its endurance test, there can be little doubt as to its outstanding quality – a 100 % dormakaba product in every respect.



Transom-concealed door closer

In the case of VISUR all-glass double-action door, the closing function is performed invisibly by the transom-concealed RTS 85 EN 3 door closer. This not only reliably returns the door to its zero position after each opening action, but also – thanks to special check back damping – protects the leaf from careless impact arising from excessive opening force. Thanks to a hold-open feature included as standard, the door can also be

retained at an opening angle of 90°. Clampable projections – leaf-integral 'tongues' – provide the mating connection for the concealed pivot fittings top and bottom. Hidden within the floor is the bottom bearing housing with the pivot bearing mounting designed for an offset of 70 mm.

The depth of installation is 64 mm and the diameter of the bearing housing is just 126 mm.



Scope of delivery

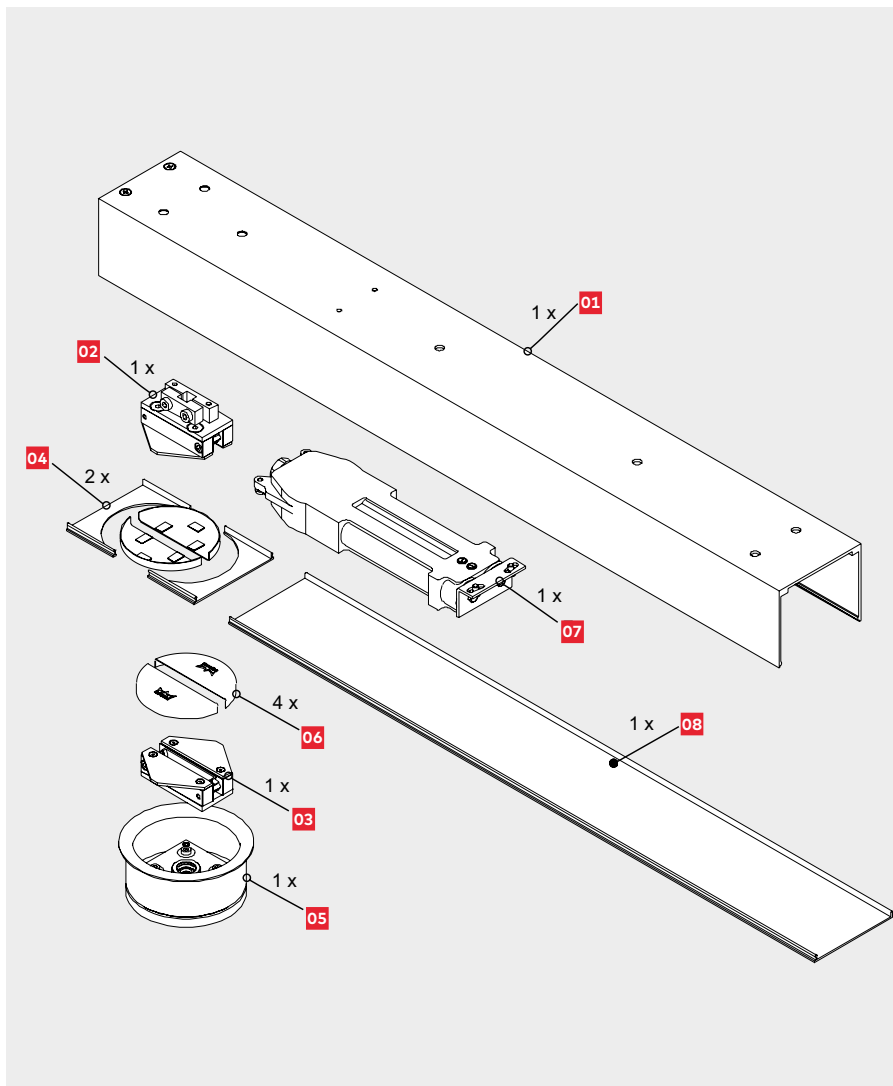

- 01**
transom tube for installation under the ceiling
1 part for max. panel width 1,100 mm
2 parts for max. panel width 2 x 1,100 mm
- 02**
glass clamping piece top
- 03**
glass clamping piece bottom
- 04**
cover profile parts for door closer pivot pin 90 mm
- 05**
bottom bearing housing with cover ring
- 06**
cover caps
- 07**
RTS 85 EN 3, 90° retainer (for door widths smaller than 800 mm optionally the door closer variant EN 2 can be used. Please quote requirement with your order.)
- 08**
transom tube cover

Technical features

Pivoting door:

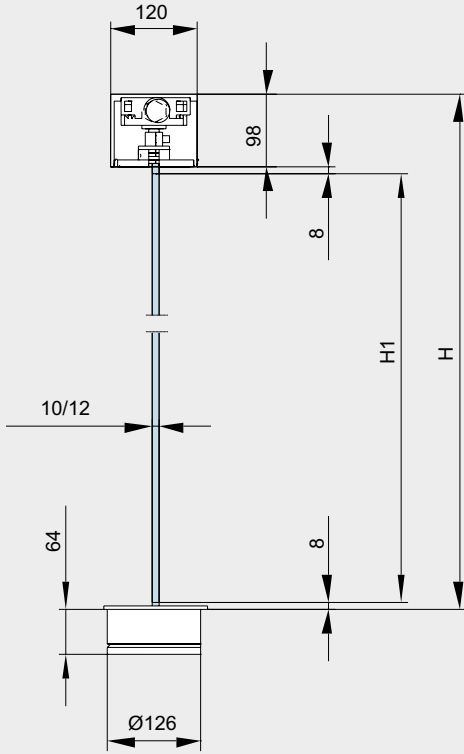

Materials and finishes

- Aluminum, AL EV1-Deco anodized (compatible with finish 150) (114)

Dimensions

- Glass thickness: 10 / 12 mm
- max. door panel weight: 85 kg
- max. door panel width (B1): 1,100 mm
- max. door panel height (H1): 2,500 mm

Calculation of glass measurements:

$H1 = H - 114$
 $B1 \text{ single leaf} = B - 10$
 $B1 \text{ double leaf} = \frac{B - 15}{2}$

Fixed panel:

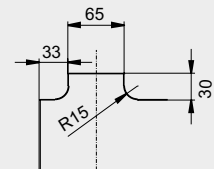
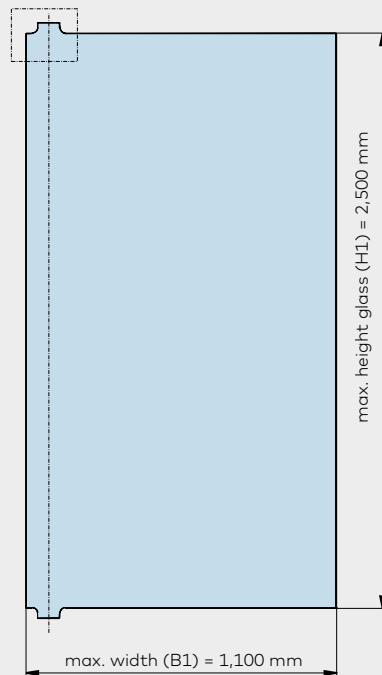
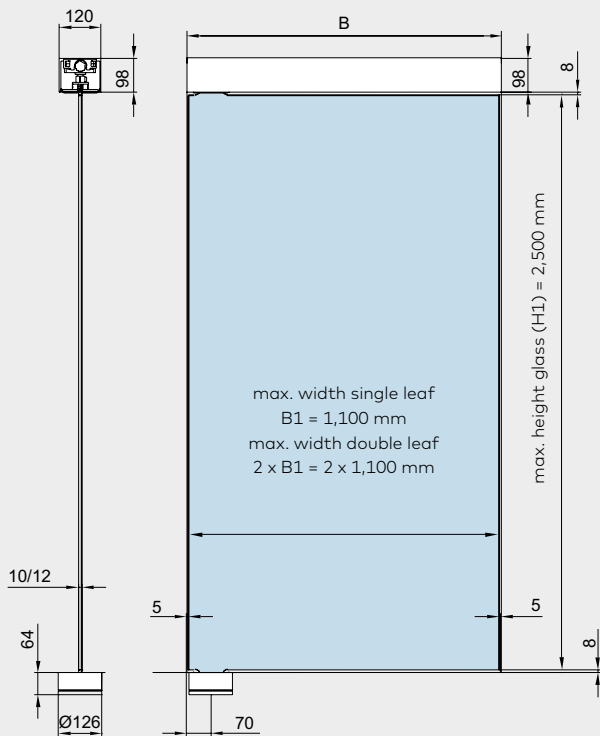
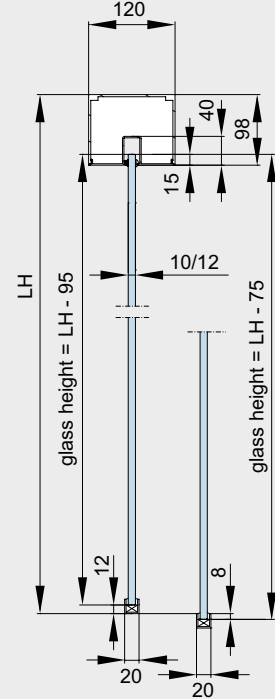

Design of the top glass 'tongue' and the bottom glass 'tongue' is alike

VISUR complete sets

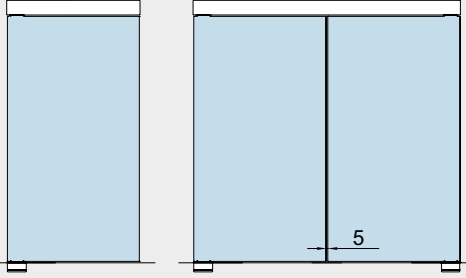
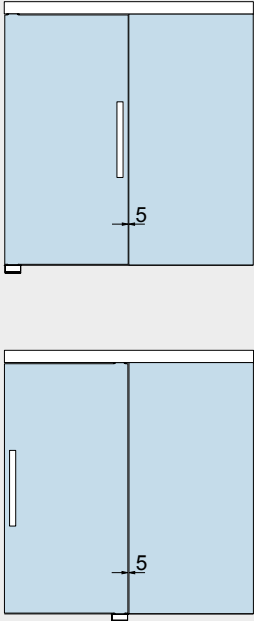
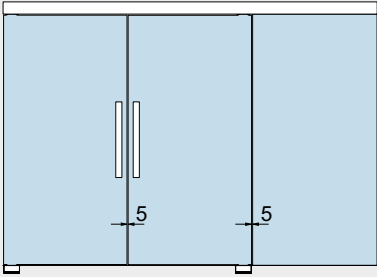
	Product description	Art. No.
	<p>Complete set for single leaf doors incl. transom tube, RTS 85, top and bottom pivot</p> <p>do. for double leaf door</p> <p>Attention: Please indicate with your order clear width in mm. Max. assembly width: 1,100 mm (03.770) Max. assembly width: 2,200 mm (03.771)</p>	<p>03.770</p> <p>03.771</p>
	<p>Complete set for single leaf doors with one fixed sidelight incl. transom tube, RTS 85, top and bottom pivot</p> <p>Attention: Please indicate with your order the clear width and the width of sidelights and doors in mm. Max door width 1,100 mm, max. assembly width 6,000 mm</p>	<p>03.790</p>
	<p>do. for double leaf door with one sidelight</p> <p>Attention: Please indicate with your order the clear width and the width of sidelights and doors in mm. Max door width 1,100 mm, max. assembly width 6,000 mm</p>	<p>03.792</p>

VISUR complete sets

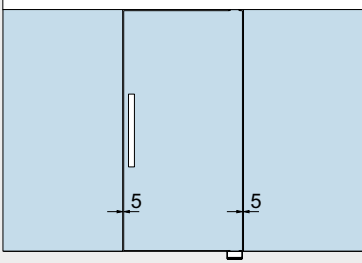
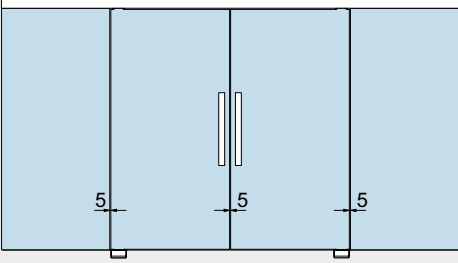
	Product description	Art. No.
	<p>do. for double leaf door with fixed sidelight incl. transom tube, RTS 85, top and bottom pivot</p> <p>Attention: Please indicate with your order the clear width and the width of sidelights and doors in mm. Max door width 1,100 mm, max. assembly width 6,000 mm</p>	<p>03.791</p>
	<p>do. for double leaf door with two fixed sidelights</p> <p>Attention: Please indicate with your order the clear width and the width of sidelights and doors in mm. Max door width 1,100 mm, max. assembly width 6,000 mm</p>	<p>03.793</p>

VISUR components

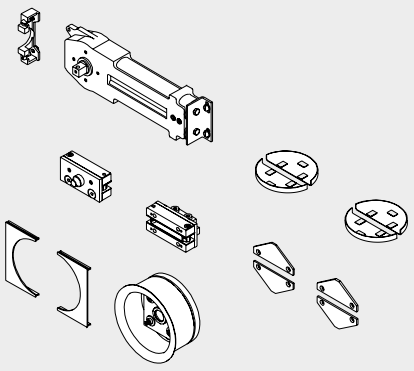
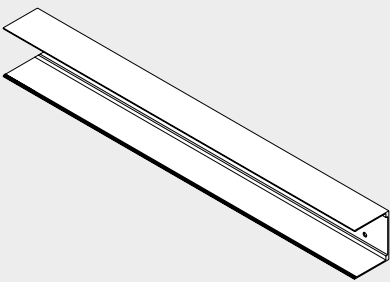
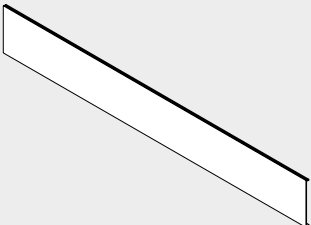
	Product description	Art. No.
	VISUR set composed of RTS 85, top and bottom pivot	03.772
	VISUR set composed of top and bottom pivot, (without RTS 85) When installing the glass door, make sure there is sufficient space in the ceiling/transom!	03.773
	VISUR transom tube profile for single leaf doors (max. 1,100 mm door panel width), in fixed length (please indicate with your order the clear width in mm)	03.775
	do. for double leaf doors (max. 2 x 1,100 mm door panel width), in fixed length (please indicate with your order the clear width in mm)	03.776
	VISUR transom tube profile in stock length 6,000 mm	03.789
	VISUR transom tube cover profile for single leaf doors (max. 1,100 mm door panel width), in fixed length (please indicate with your order the clear width in mm)	03.777
	do. for double leaf doors (max. 2 x 1,100 mm door panel width), in fixed length (please indicate with your order the clear width in mm)	03.778
	VISUR transom tube cover profile in stock length 6,000 mm	03.780

Content

RP

152	General information
153	Type illustrations
154	Components
164	Handle bars, door knobs, recessed pull grips and brush seals
169	Safety-related information



RP

Marvellously concealed transom door closer

The RP pivot door system works with a tubular transom profile in which the RTS transom closer is integrated and concealed. The system is fixed on the ceiling using brackets which are concealed after system installation. A top patch fitting (UNIVERSAL PT 22) attaches the all-glass door to the closer. A bottom patch fitting (UNIVERSAL PT 10) connects the door to the floor pivot, which measures only a few centimetres. So glass thicknesses of 8 – 12 mm are feasible.

The UNIVERSAL patch fittings can be replaced by door rails top and bottom or MUNDUS patch fittings as a special option. When using MUNDUS Premium patch fittings, you also have the option of installing laminated safety glass (LSG).

The RTS transom closer not only returns the door to the zero position each time it is opened, it also has a special dampening system to protect the door against unwanted impact caused by over-aggressive opening. In addition, the integral hold-open, which also comes as standard, enables the door to be held open at an angle of 90°.

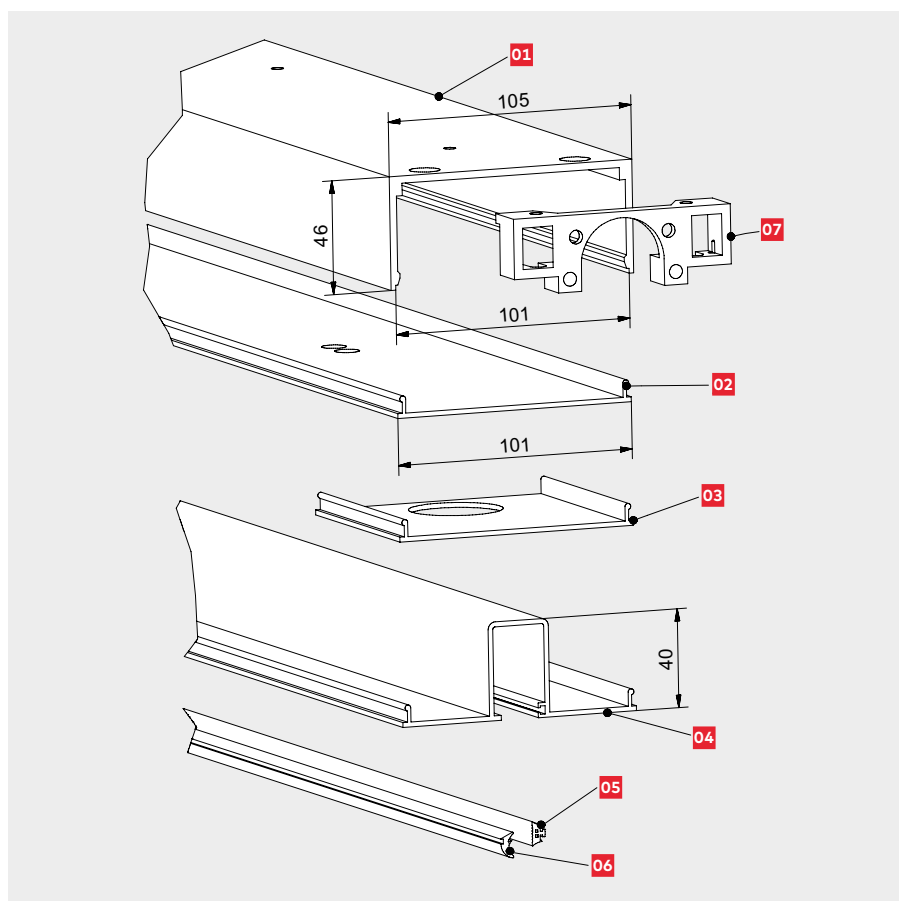

Transom tube configuration:

- 01**
Transom tube for fixing on ceiling, as lintel or similar, max. length 6,000 mm
- 02**
Cover profile for door, clip-on, max. length 6,000 mm
- 03**
Cover profile for fixed sidelights, clip-on type with glass groove
- 04**
Cover profile for fixed sidelights, clip-on, with glazing groove
- 05 / 06**
Contact profile / glass wedge profile, depending on combination for 8, 10 or 12 mm glass thicknesses of the sidelight
- 07**
Fixing bracket for securing transom tube and closer

Type selection

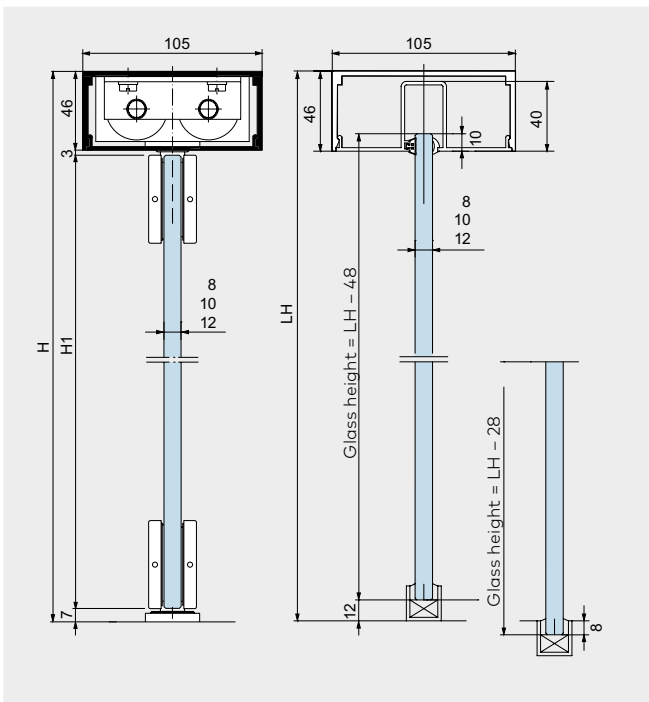
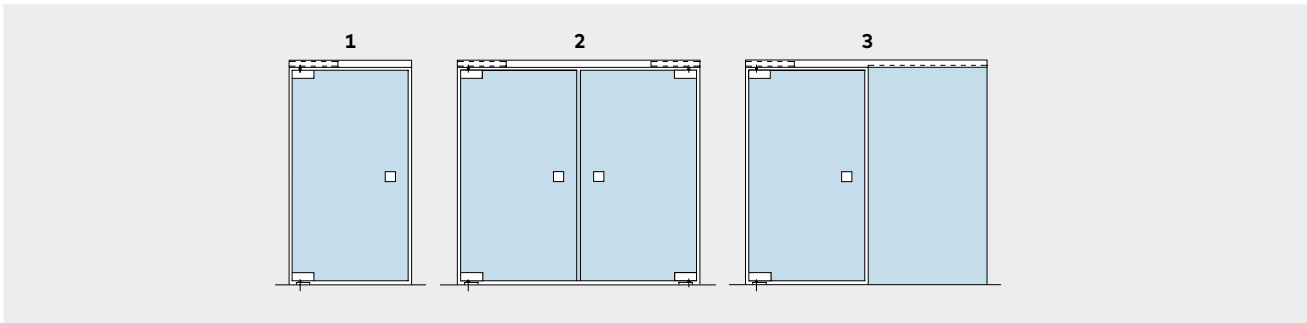

Options

- 1 Single leaf double-action door with transom tube
- 2 Pair of double-action doors with transom tube
- 3 Double-action door with through-running transom tube and fixed sidelight

Further versions up to 6000 mm are possible.

Materials and finishes

- Aluminum, silver EV1 anodized (similar Eloxal I EV1 / Eloxal II C 0) (101)
- Aluminum, similar satin stainless steel anodized (for profile material) (similar Eloxal II C 31) (113)
- Aluminum, traffic white powder coated (300)
- Aluminum special color anodized (199)
- Aluminum, special color powder coated (399)

Door panel dimensions

- Glass thicknesses: 8 / 10 / 12 mm
- Door height H1: H - 56 mm
- For max. door panel weights and widths please see the table below.

Sidelight dimensions

- Glass thickness: 8 / 10 / 12 mm with two-part sealing profile
- Sidelight height: H - 28 mm + floor pocket, where required

Also with door rails available

max. height	max. width	max. door weight (incl. fittings)	RTS version	
2,500	800-1,100	80 kg	RTS EN 3	
3,500	max. 1,250	110 kg	RTS EN 4	

with door rails top and bottom see detail sheets 04-030 and 04-060

If you have any questions regarding special designs with door rails or MUNDUS patch fittings, our Application Engineering department will be glad to advise you.

Double-action system for glass doors

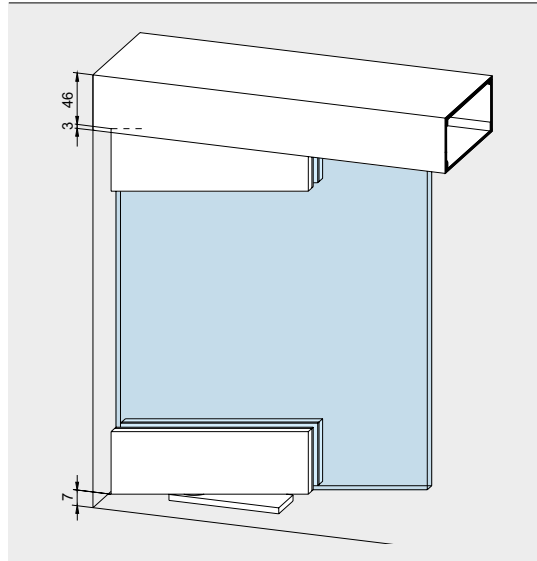
	Product description	Art. No.
	<p>Double-action system for glass doors complete, consisting of 1 transom tube length 1,000 mm; 1 cover profile length 1,000 mm; 1 RTS 85 transom closer; EN3, hold open 90° (For door widths less than 800 mm, door closers of spring strength EN 2 may also be used. Please indicate requirement when ordering.) 1 fixing bracket; 1 bottom patch fitting PT 10; 1 top patch fitting PT 22; 1 floor pivot bearing</p> <p>Weight in kg: 8.083</p> <p>When ordering, please indicate the precise system dimensions or attach a corresponding drawing.</p>	01.300

	Product description	Art. No.
	<p>01 Transom tube for fixing at ceiling, as lintel, or similar, stock length 6,000 mm in fixed lengths Weight in kg/m: Aluminum 1.620</p>	<p>01.301 01.311</p>
	<p>02 Cover profile for door area, clip-on stock length 6,000 mm in fixed lengths Weight in kg/m: Aluminum 0.610</p>	<p>01.302 01.305</p>
	<p>03 Cover plate with cut-out for door closer spindle length 90 mm Weight in kg: Aluminum 0.056</p>	<p>01.303</p>
	<p>04 Cover profile with glass groove to clip on Art.No. 01.301 / 311, to hold fixed sidelights inclusive</p>	
	<p>05 / 06 Contact profile or glass wedge profile in 2 resp. 4 mm thicknesses, depending on combination for 8, 10 or 12 mm glass thickness of the sidelight stock length 6,000 mm in fixed lengths Weight in kg: Aluminum 0.810</p>	<p>01.304 01.314</p>
	<p>07 Fixing bracket for securing transom tube and closer Weight in kg: Aluminum 0.080</p>	<p>01.306</p>

Content

Accessories

- 158 **Handle bars, door knobs, recessed pull grips**
- 168 **Finishes and colours**
- 175 **Safety-related information**



Accessories

Pull handles, door knobs and recessed pull grip

The pull handle/knob system is designed for glass of 8, 10 and 12 mm thickness.

The pull handles can be fixed to both sliding and pivoting (swing) doors on one face using the appropriate connectors or on both faces by through-bolting (back-to-back arrangement).

Due to a flat structure recessed pull grips are also suitable for sliding doors.

The single-point fixings and through bolts are included as standard equipment in the scope of supply.



The pull handles can be fitted horizontally, vertically or in a handrail arrangement.

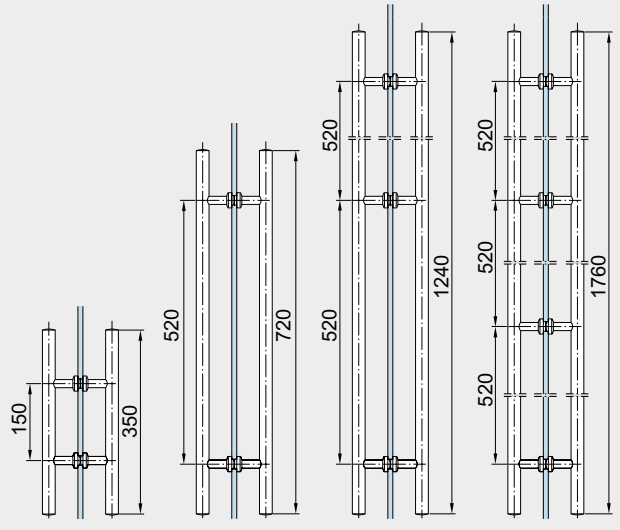
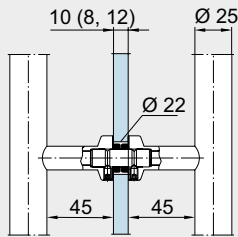
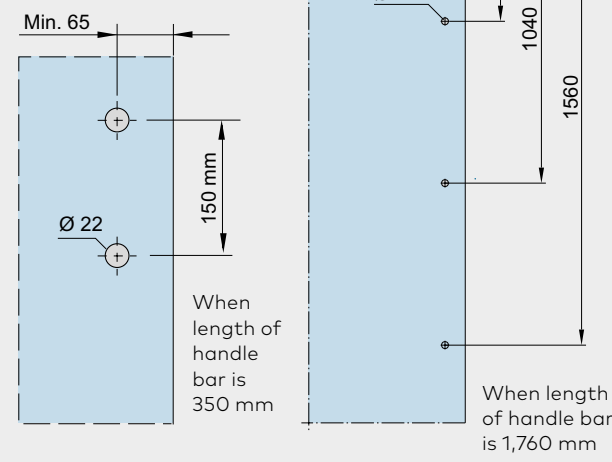

	Product description	Glass thickness	Art. No.
	Pair of handle bars satin stainless steel length 350 mm, 2 fixing points, weight in kg: 1.254 material 1.4305 do., material 1.4404	8/10/12 mm	21.267* 21.247
	Pair of handle bars aluminum length 350 mm, 2 fixing points, weight in kg: 1.326 aluminum	8/10/12 mm	03.400
	Pair of handle bars satin stainless steel length 720 mm, 2 fixing points, weight in kg: 1.947 material 1.4305 do., material 1.4404	8/10/12 mm	21.270* 21.250
	Pair of handle bars aluminum length 720 mm, 2 fixing points, weight in kg: 2.423 aluminum	8/10/12 mm	03.402
	Pair of handle bars satin stainless steel length 1,240 mm, 3 fixing points, weight in kg: 3.400 material 1.4305 do., material 1.4404	8/10/12 mm	21.273* 21.253
	Pair of handle bars satin stainless steel length 1,760 mm, 4 fixing points, weight in kg: 5.000 material 1.4305 do., material 1.4404	8/10/12 mm	21.276* 21.256

* Conversion sets for back to back pull handles for timber doors resp. other glass thicknesses see unter "Spacing adjustment for pull handles and door knobs", page 217.

Pull handles single

	Product description	Glass thickness	Art. No.
	Pull handles with single-point fixings, countersunk Edelstahl	8/10/12 mm	
	Pull handle 350 mm with 2 fixings, material 1.4305 do., AISI 316L		29.268
	Pull handle 720 mm with 2 fixings, material 1.4305 do., AISI 316L		29.269
	Pull handle 1,240 mm with 3 fixings, material 1.4305 do., AISI 316L		29.271
	Pull handle 1,760 mm with 4 fixings, material 1.4305 do., AISI 316L		29.272
	Pull handles with single-point fixings, clamping disc	8/10/12 mm	
	Pull handle 350 mm with 2 fixings, material 1.4305 do., AISI 316L		21.240
	Pull handle 720 mm with 2 fixings, material 1.4305 do., AISI 316L		21.241
	Pull handle 1,240 mm with 3 fixings, material 1.4305 do., AISI 316L		21.242
	Pull handle 1,760 mm with 4 fixings, material 1.4305 do., AISI 316L		21.243

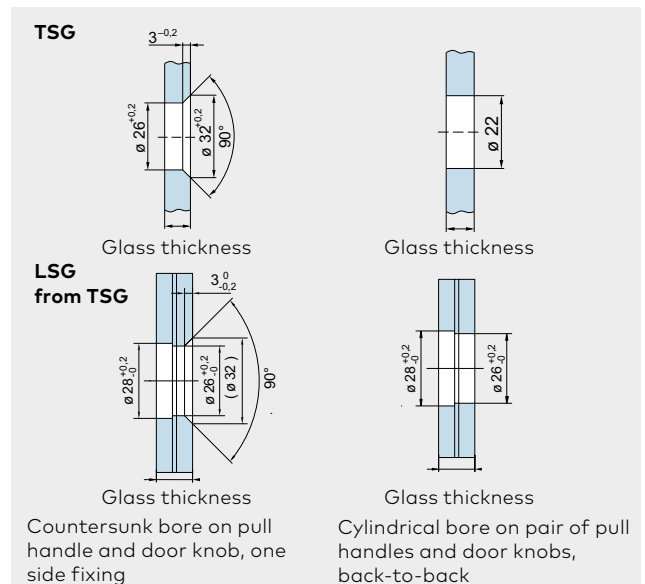
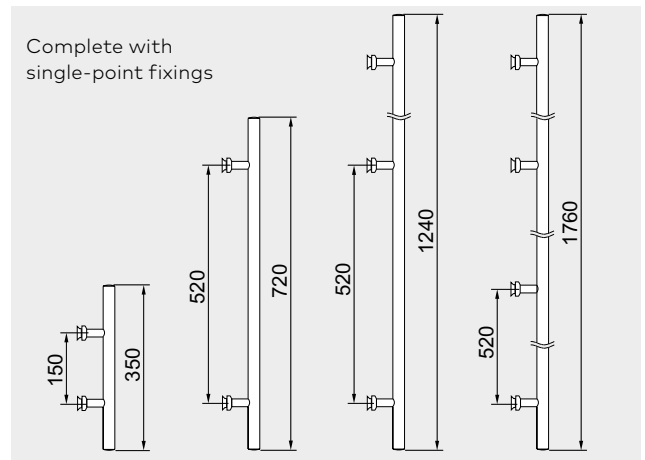
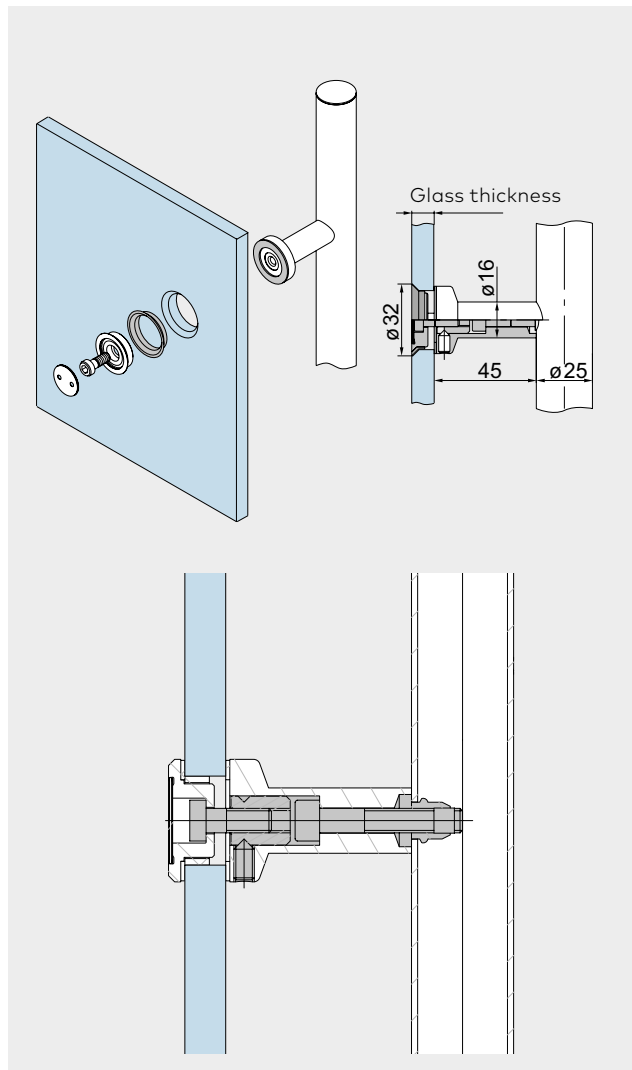

Spacing adjustment for pull handles and door knobs

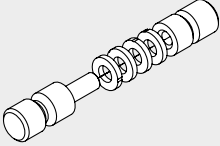
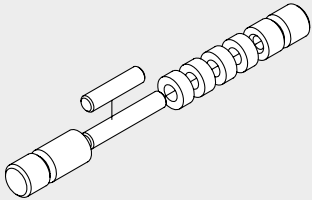
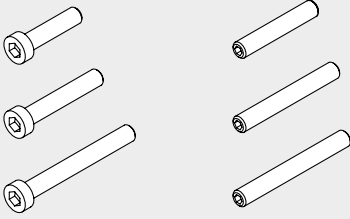
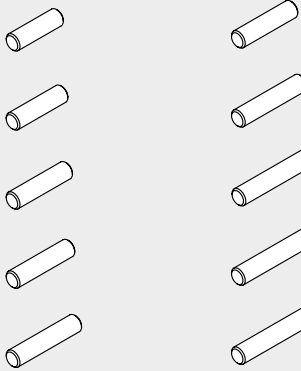
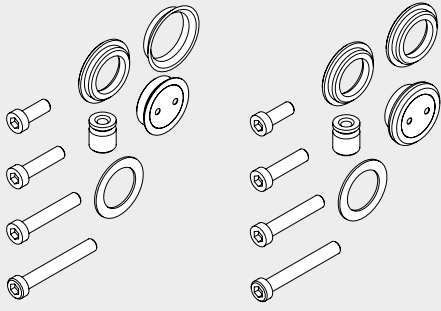
	Product description	Door thickness	Art. No.
 <p>Distance washer 2 mm</p>	Conversion set 1 for glass doors, pair of pull handles / knob back-to-back without distance washer with 1 distance washer with 2 distance washers with 3 distance washers with 4 distance washers	13.5 – 21.5 mm 13.5 mm 15 mm 17.5 mm 19 mm 21.5 mm	21.285
 <p>Distance washer 5 mm</p>	Conversion set 2 for timber doors, pair of pull handles / knob back-to-back without distance washer with 1 distance washer with 2 distance washers with 3 distance washers with 4 distance washers	20 – 40 mm 20 mm 25 mm 30 mm 35 mm 40 mm	21.286
 <p>Set 3 Set 4</p>	Conversion set 3 for glass / timber doors*, pair of pull handles / knob back-to- back, countersunk 15 - 40 mm glass / timber thickness		21.287
	Conversion set 4 for glass / timber doors* , pair of pull handles / knob back- to-back, clamping disc 15 - 40 mm glass / timber thickness		21.288
 <p>Set 5 Set 6</p>	Conversion set 5 for glass doors* , recessed pull grip 13.5 - 21.5 mm glass thickness		21.295
	Conversion set 6 for timber doors* , recessed pull grip 20 - 40 mm timber thickness		21.296
 <p>Set 7 Set 8</p>	Conversion set 7 for glass / timber doors* , for pull handles fixed on both sides to pull handle fixed on one side, countersunk 8 - 40 mm glass / timber thickness 1 set per pull handle fixing		21.297
	Conversion set 8 for glass / timber doors* , for pull handles fixed on both sides to pull handle fixed on one side, clamping disc 8 - 40 mm glass / timber thickness 1 set per pull handle fixing		21.298

*Not suitable for Arcos pull handles 26.500 / 26.510

Pair of pull handles

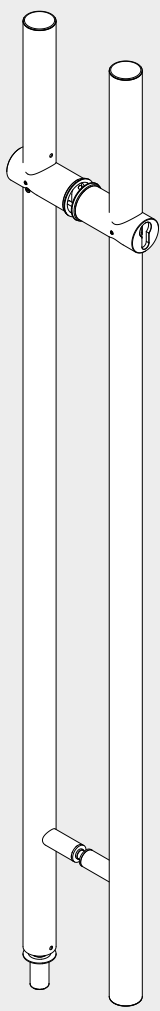
	Product description	Glass thickness	Art. No.
	Pair of stainless steel handlebars, lockable on both sides, prepared for standard PZ, length 1200 mm, incl. floor socket	8 - 17.5 mm	21.580
	Pair of stainless steel handlebars, lockable on one side, prepared for standard PZ, length 1200 mm, incl. floor socket	8 - 17.5 mm	21.581
	Further information, e.g. on the required profile cylinder length, can be found in our detail on the sheets 29-115 to 29-116.		

Arcos pull handle

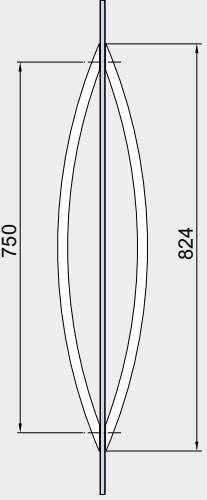
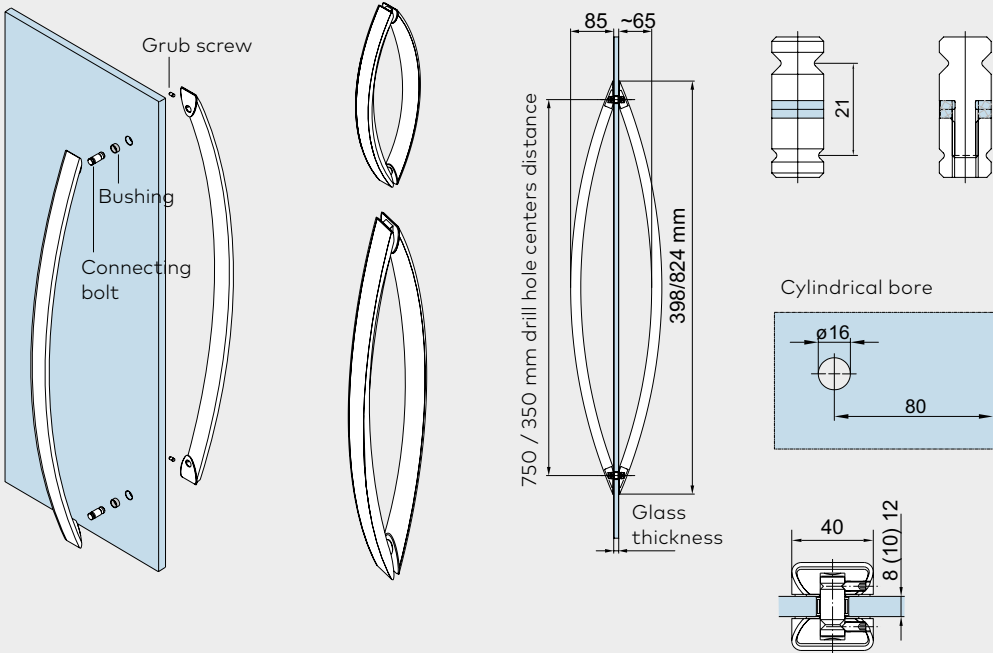
	Product description	Glass thickness	Art. No.
	<p>Arcos pair of pull handle incl. connecting bolt Aluminium, stainless steel look</p> <p>Pull handle 350 mm with 2 fixings Pull handle 750 mm with 2 fixings</p>	<p>8/10/12 mm</p>	<p>26.500 26.510</p>
			

Handle bars

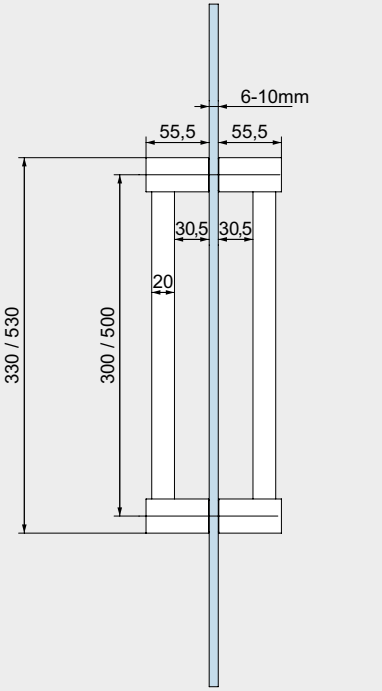
	Product description	Art. No.
	<p>Pull handle "Quadrat" Glas thickness 6 - 10 mm with 2 fixings Ø 12 mm</p> <p>Length 300 mm Length 500 mm</p>	<p>75.084 75.085</p>

Recessed pull grips and door knobs

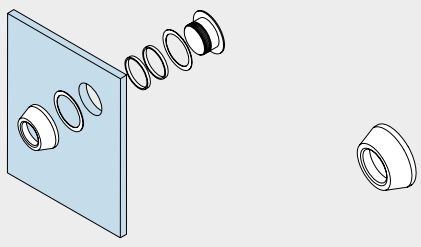
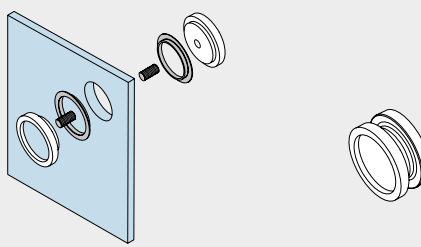
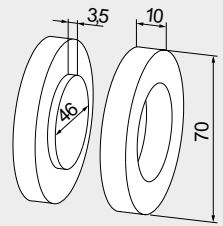
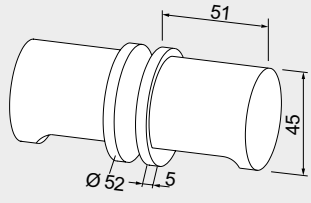
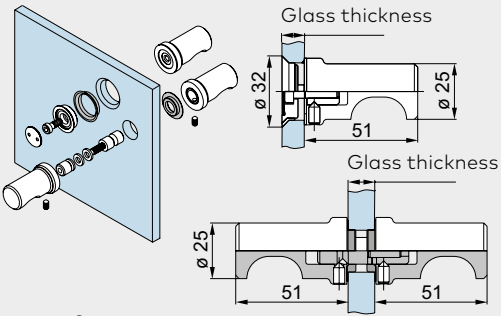
	Product description	Glass thickness	Art. No.
 <p>Ø 38 mm Glass bore</p>	Recessed pull grip Ø 50 mm	8/10/12 mm	21.290
 <p>Ø 50 mm Glass bore</p>	Recessed pull grip Ø 60 mm	8/10/12 mm	21.291
	Recessed pull grip with grip hole Ø 60 mm	8 mm 10 mm 12 mm	21.292 21.293 21.294
 <p>Ø 50 mm Glass bore</p>	Recessed pull grip aluminum to be glued onto the glass Weight in kg: 0.072		07.200
 <p>Ø 20 mm Glass bore</p>	Door knob, aluminum Weight in kg: 0.400		07.201
 <p>Single-point fixing clamping disc (Ø 22 mm)</p> <p>(Glass preparation please see under "pull handles single", page 216)</p>	Door knob one side fixing Door knob with single-point fixing, countersunk Door knob with single-point fixings, clamping disc	8/10/12 mm	21.422 21.426
	Door knob back-to-back	8/10/12 mm	21.423

Note: To ensure better load transmission, please use a pull handle in conjunction with the DORMOTION damping unit.

Accessories / Assembling aid

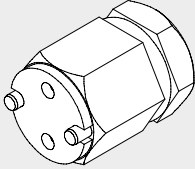
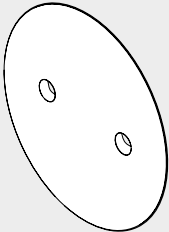
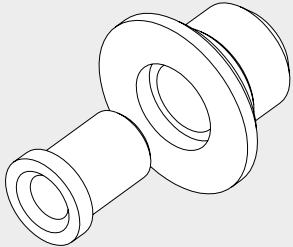
	Product description	Art. No.
	Assembling tool for MANET single-point fixing	21.134
	Clip-on cover for single-point fixing with spring, 5 pieces material 1.4305 do.material 1.4404	29.217 29.219
	Drilling jig for MANET single-point fixing serie S32/35	21.137

Space for your notes

Finishes and colours

All the common patterns and types are available ex-stock (factory) with the following finishes and colours.

Specials and glass assemblies in bespoke colour anodising and powder coating will be prepared promptly.

Standard finishes and colours	STUDIO Rondo	STUDIO Classic	STUDIO Gala 2.0	STUDIO Arcos	STUDIO Medio	OFFICE Junior	OFFICE Classic	OFFICE Mundus	OFFICE Arcos	BEYOND	TENSOR	VISUR	RP Patch fittings
Aluminum, silver EV1 anodized (similar Eloxal I EV1/Eloxal II C 0) (101)													•
Aluminum, similar satin stainless steel anodized (107)						•				•			
Aluminum, AL similar satin stainless steel anodized (for profile material) (similar Eloxal II C 31) (113)											•		•
Aluminum, EV1-Deco anodized (compatible with finish 150) (114)				•					•	•	•	•	
Aluminum, silver anodized (Silver N 600 ST) (compatible with finish 114) (150)	•	•	•		•	•	•	•					
Aluminum, niro anodized (Niro N 700) (157)	•	•	•	•	•	•	•	•	•				
Aluminum, special color anodized (199)	•	•		•	•	•	•	•	•				•
Aluminium, special color powder coated (Standard powder according to RAL) (399)	•	•		•	•	•	•	•	•				•
Brass, polished chrome (501)	•												
Brass, polished varnished (502)	•												
750 / 700 satin stainless steel						•		•					
751 / 701 polished stainless steel								•					

Safety-related information

Important safety-related information for the mounting and use of dormakaba glass fittings.

(Follow these instructions in addition to the mounting and operating instructions in order to avoid damage of product and damage to person or property.)

Important: All users have to be informed about relevant points mentioned in these safety-related information and the mounting and operating instructions!

General information

- dormakaba recommends the use of TSG-H (heat-stored tempered safety glass) according to DIN EN 12150-1.
- dormakaba glass fittings are not suitable for outdoor installation.
- dormakaba glass fittings are not suitable for rooms where chemicals (e.g. chlorine) are used, e.g. swimming pools, saunas and brine baths.



- Sliding panels must not be moved faster than at walking speed and must be stopped by hand before reaching the end position will be.
- Pivoting panels must not be thrown too hard. If there is a risk of over-turning, this must be prevented by a door stop.

Mounting

- Only properly qualified and specially trained staff is authorised to mount dormakaba glass fittings.
- Never use glass with conchoidal fractures and/or damaged edges.
- Due to crushing hazards – among others in the area of the secondary closing edge – and possible injury caused by breakage of glass during mounting, corresponding protective clothing (especially gloves and protective goggles) is required.
- Clean clamping area with fat solvent (standard commercial cleaning agent) before mounting the glass fitting.
- Never use clamping shoes on structured glass surfaces (except on satined glass) or glass of heavily varying thickness unless with a corresponding levelling layer.
- Never use clamping shoes on self-cleaning coatings.
- When adjusting glass elements, always stick to the required clearance for the respective fitting. Adjust clearance so that the glass does not touch hard components such as glass, metal or concrete.
- Make sure not to use excessive force when installing the glass (avoid local stress resulting from very tight screws).

Maintenance

Check fittings at regular intervals for proper positioning and smooth running and door for correct adjustment. Especially highly-frequented door systems require inspection by properly qualified staff (specialised companies or installation firms). Immediately replace damaged glass elements (no glass flaking and/or conchoidal fractures)!

General care instructions

The surface finishes of the fittings are not maintenance-free and should be cleaned according to their material and design.

- For metallic surfaces (anodised finishes, stainless steel) please use appropriate cleaning agents without abrasive additives only.
- For varnished surfaces please use appropriate solvent-free cleaning agents only.
- Brass surfaces (without surface protection) have to be treated with an appropriate maintenance agent on occasion, to avoid tarnishing.

For practical planning, please use our drawings dormakaba "The Detail".

The printed colours indicating the surface finishes are not 100 % true, but do provide a useful guide. Statements made with regard to the nature or use of the products are for the purposes of descriptions. Assent with regard to the existence of particular properties or particular uses always requires special written agreement. Pictures may show special designs which are different to the standard scope of delivery.

Subject to change without notice.



www.glas-innovationen.com/en



**Door
Hardware**



**Electronic
Access & Data**



**Mechanical
Key Systems**



Lodging Systems



**Entrance
Systems**



**Interior Glass
Systems**



Safe Locks



Service

dormakaba
International Holding AG
Hofwisenstrasse 24
CH-8153 Rümlang
T +41 44 818 90 11
info@dormakaba.com
www.dormakaba.com

Manual Single-Action Double-Door Systems

Technical brochure 2021

dormakaba

